

TLC1078, TLC1078Y, TLC1079, TLC1079Y LinCMOS™ μ POWER PRECISION OPERATIONAL AMPLIFIERS

SLOS179A – FEBRUARY 1997 – REVISED MARCH 2001

- Power Dissipation as Low as 10 μ W Typ Per Amplifier
- Operates on a Single Silver-Oxide Watch Battery, $V_{DD} = 1.4$ V Min
- $V_{IO} \dots 450 \mu\text{V}/850 \mu\text{V}$ Max in DIP and Small-Outline Package (TLC1078/79)
- Input Offset Voltage Drift $\dots 0.1 \mu\text{V}/\text{Month}$ Typ, Including the First 30 Days
- High-impedance LinCMOS™ Inputs
 $I_{IB} = 0.6$ pA Typ
- High Open-Loop Gain $\dots 800000$ Typ
- Output Drive Capability > 20 mA
- Slew Rate $\dots 47$ V/ms Typ
- Common-Mode Input Voltage Range Extends Below the Negative Rail
- Output Voltage Range Includes Negative Rail
- On-Chip ESD-Protection Circuitry
- Small-Outline Package Option Also Available in Tape and Reel

description

The TLC107x operational amplifiers offer ultra-low offset voltage, high gain, 110-kHz bandwidth, 47-V/ms slew rate, and just 150- μ W power dissipation per amplifier.

With a supply voltage of 1.4 V, common-mode input to the negative rail, and output swing to the negative rail, the TLC107xC is an ideal solution for low-voltage battery-operated systems. The 20-mA output drive capability means that the TLC107x can easily drive small resistive and large capacitive loads when needed, while maintaining ultra-low standby power dissipation.

Since this device is functionally compatible as well as pin compatible with the TLC27L2/4 and TLC27L7/9, the TLC107x easily upgrades existing designs that can benefit from its improved performance.

TLC1078
D, JG, OR P PACKAGE
(TOP VIEW)

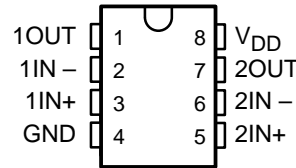

TLC1079
D, J, OR N PACKAGE
(TOP VIEW)

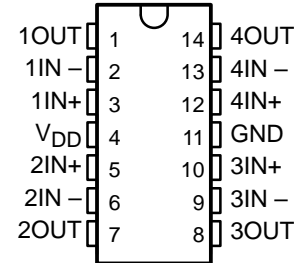

TLC1078
FK PACKAGE
(TOP VIEW)

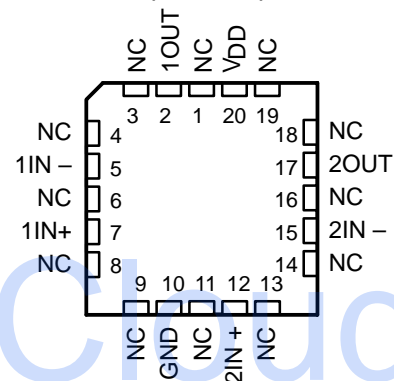

TLC1079
FK PACKAGE
(TOP VIEW)

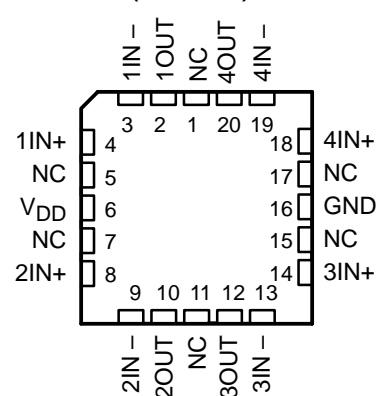

NC – No internal connection



Please be aware that an important notice concerning availability, standard warranty, and use in critical applications of Texas Instruments semiconductor products and disclaimers thereto appears at the end of this data sheet.

LinCMOS is a trademark of Texas Instruments Incorporated.

PRODUCTION DATA information is current as of publication date. Products conform to specifications per the terms of Texas Instruments standard warranty. Production processing does not necessarily include testing of all parameters.



Copyright © 2001, Texas Instruments Incorporated

TLC1078, TLC1078Y, TLC1079, TLC1079Y

LinCMOS™ μ POWER PRECISION OPERATIONAL AMPLIFIERS

SLOS179A – FEBRUARY 1997 – REVISED MARCH 2001

description (continued)

The TLC107x incorporates internal ESD-protection circuits that will prevent functional failures at voltages up to 2000 V as tested under MIL-PRF-38535, Method 3015.2; however, care should be exercised when handling these devices as exposure to ESD may result in degradation of the device parametric performance. The TLC107x design also inhibits latch-up of the device inputs and outputs even with surge currents as large 100 mA.

The C-suffix devices are characterized for operation from 0°C to 70°C. The I-suffix devices are characterized for operation from –40°C to 85°C. The M-suffix devices are characterized for operation over the full military temperature range of –55°C to 125°C. The wide range of packaging options includes small-outline and chip-carrier versions for high-density system applications.

AVAILABLE OPTIONS

T _A	PACKAGED DEVICES						CHIP FORM‡ (Y)
	SMALL OUTLINE† (D)	CHIP CARRIER (FK)	CERAMIC DIP (J)	CERAMIC DIP (JG)	PLASTIC DIP (N)	PLASTIC DIP (P)	
0°C to 70°C	TLC1078CD TLC1079CD	—	—	—	TLC1079CN	TLC1078CP	TLC1078Y TLC1079Y
–40°C to 85°C	TLC1078ID TLC1079ID	—	—	—	TLC1079IN	TLC1078IP	—
–55°C to 125°C	TLC1078MD TLC1079MD	TLC1078MFK TLC1079MFK	TLC1079MJ	TLC1078MJG	TLC1079MN	TLC1078MP	—

† The D package is available taped and reeled. Add the suffix R to the device type (e.g., TLC1078CDR).

‡ Chip forms are tested 25°C only.

symbol (each amplifier)

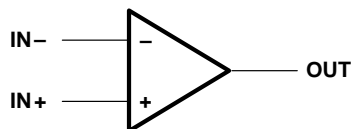

TLC1087Y chip information

This chip, when properly assembled, displays characteristics similar to the TLC1078C. Thermal compression or ultrasonic bonding may be used on the doped-aluminum bonding pads. Chips can be mounted with conductive epoxy or a gold-silicon preform.

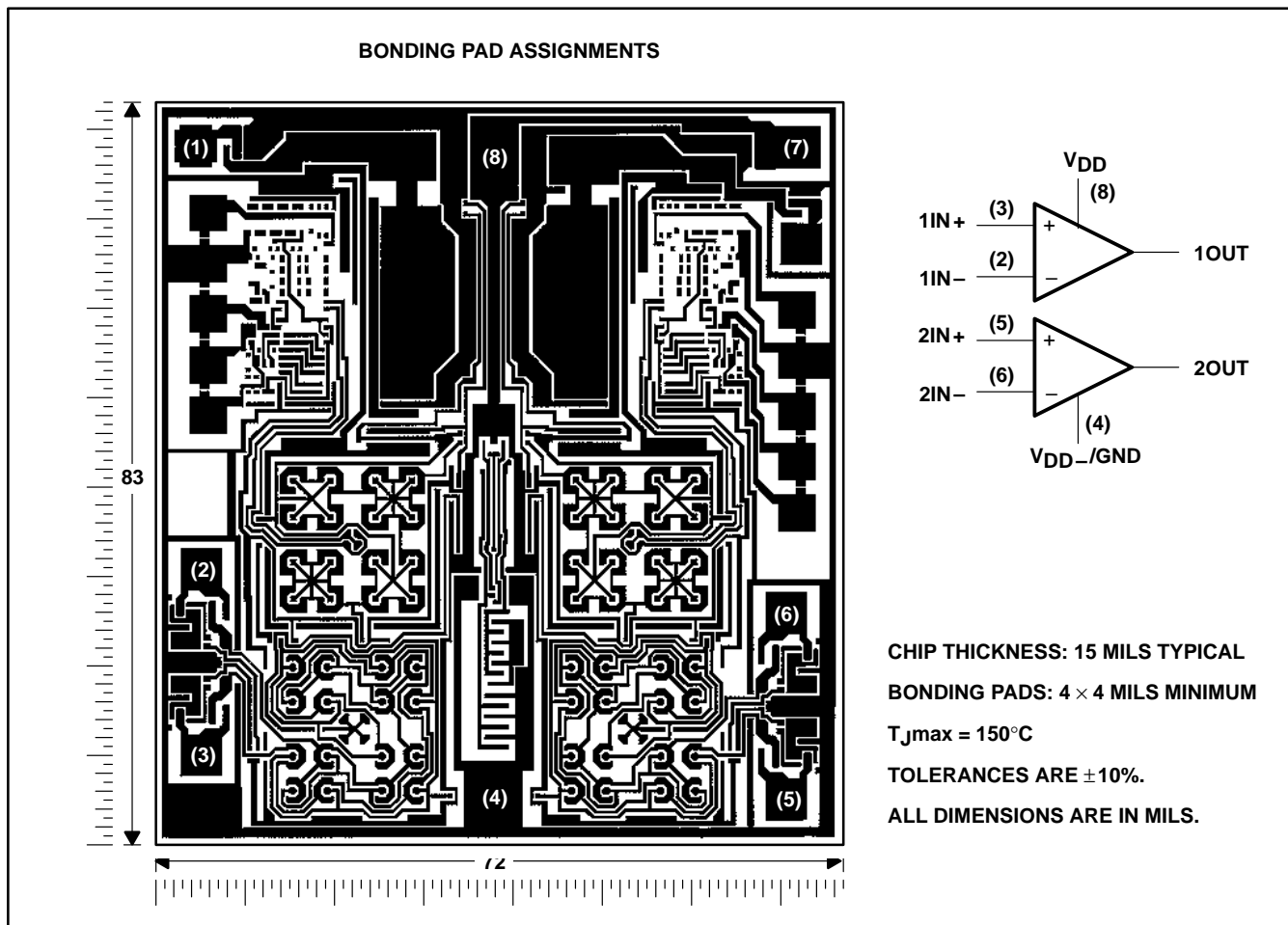

TLC1078, TLC1078Y, TLC1079, TLC1079Y
LinCMOS™ μ POWER PRECISION
OPERATIONAL AMPLIFIERS

SLOS179A – FEBRUARY 1997 – REVISED MARCH 2001

TLC1079Y chip information

This chip, when properly assembled, display characteristics similar to the TLC1079C. Thermal compression or ultrasonic bonding may be used on the doped-aluminum bonding pads. Chips can be mounted with conductive epoxy or a gold-silicon preform.

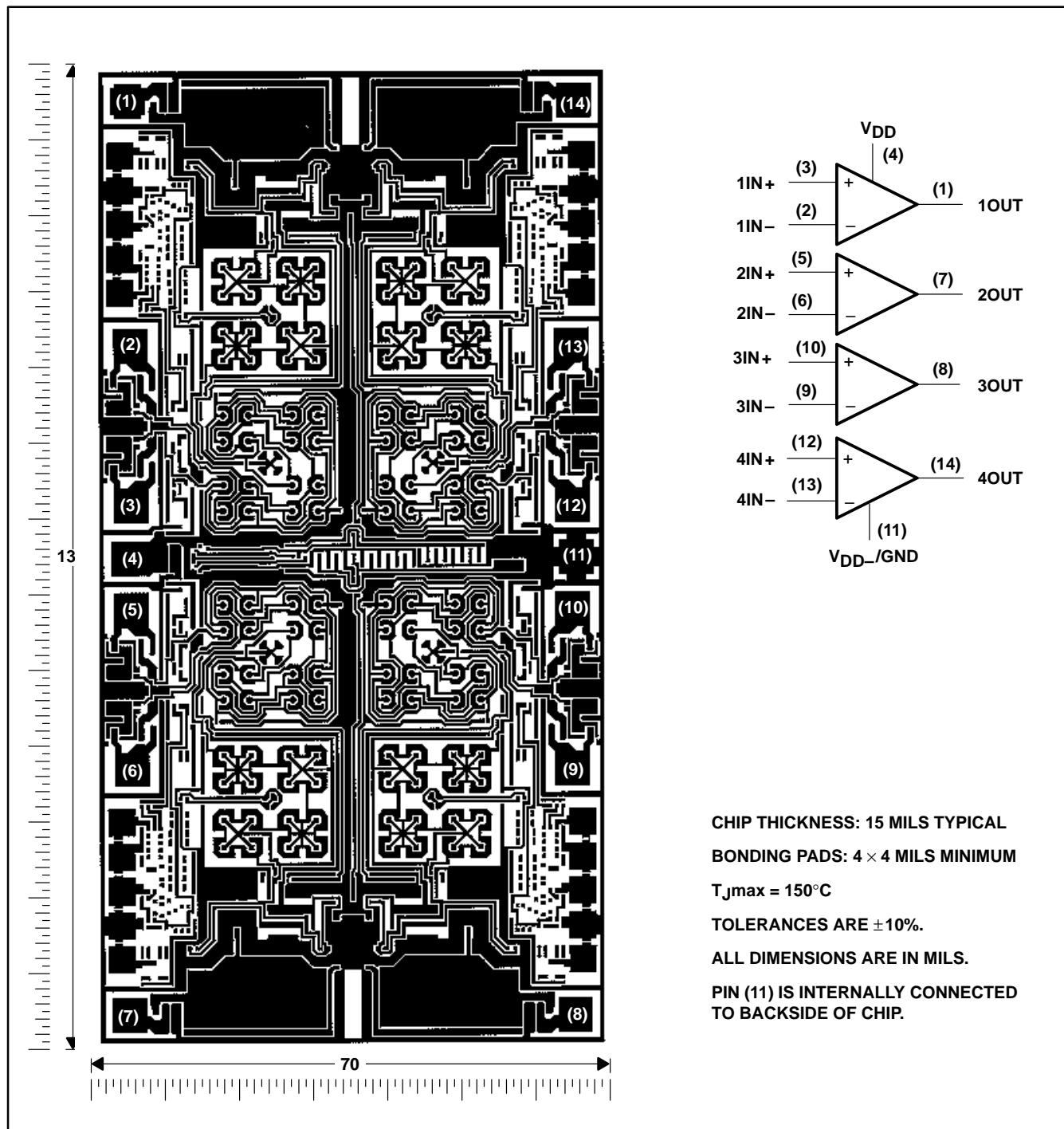

equivalent schematic (each amplifier)

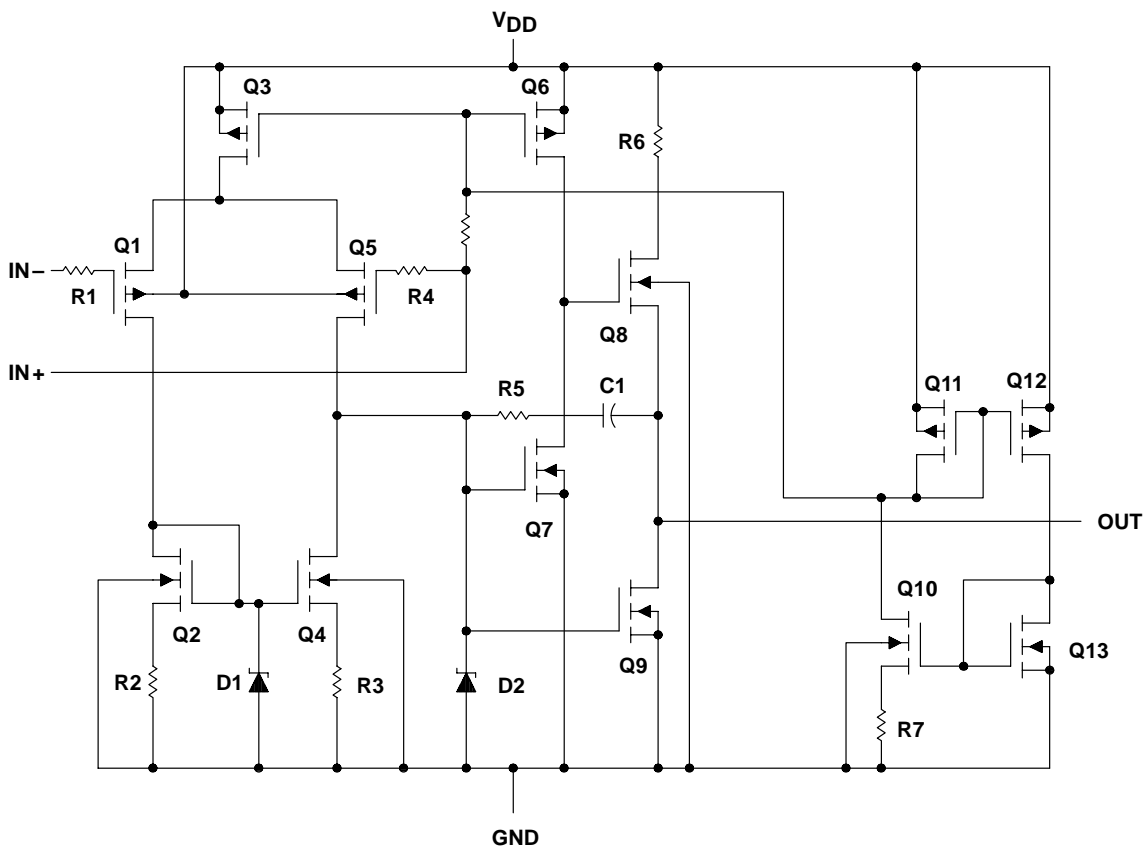

ACTUAL DEVICE COMPONENT COUNT		
COMPONENT	TLC1078	TLC1079
Transistors	38	76
Resistors	16	32
Diodes	12	24
Capacitors	2	4

absolute maximum ratings over operating free-air temperature range (unless otherwise noted)†

Supply voltage, V_{DD} (see Note 1)	18 V
Differential input voltage, V_{ID} (see Note 2)	$\pm V_{DD}$
Input voltage range, V_I (any input)	-0.3 V to V_{DD}
Input current, I_I (each input)	± 5 mA
Output current, I_O (each output)	± 30 mA
Total current into V_{DD} (see Note 3)	45 mA
Duration of short-circuit at (or below) $T_A = 25^\circ\text{C}$ (see Note 3)	unlimited
Continuous total power dissipation	see Dissipation Rating Table
Operating free-air temperature range, T_A : C suffix	0°C to 70°C
I suffix	-40°C to 85°C
M suffix	-55°C to 125°C
Storage temperature range	-65°C to 150°C
Case temperature for 60 seconds: FK package	260°C
Lead temperature 1,6 mm (1/16 inch) from case for 10 seconds: D or P package	260°C
Lead temperature 1,6 mm (1/16 inch) from case for 60 seconds: JG package	300°C

† Stresses beyond those listed under “absolute maximum ratings” may cause permanent damage to the device. These are stress ratings only, and functional operation of the device at these or any other conditions beyond those indicated under “recommended operating conditions” is not implied. Exposure to absolute-maximum-rated conditions for extended periods may affect device reliability.

- NOTES: 1. All voltage values, except differential voltages, are with respect to network ground.
 2. Differential voltages are at $IN+$ with respect to $IN-$.
 3. The output may be shorted to either supply. Temperature and/or supply voltages must be limited to ensure that the maximum dissipation ratings are not exceeded.

DISSIPATION RATING TABLE

PACKAGE	$T_A \leq 25^\circ\text{C}$ POWER RATING	DERATING FACTOR ABOVE $T_A = 25^\circ\text{C}$	$T_A = 70^\circ\text{C}$ POWER RATING	$T_A = 85^\circ\text{C}$ POWER RATING	$T_A = 125^\circ\text{C}$ POWER RATING
D-8	725 mW	5.8 mW/ $^\circ\text{C}$	464 mW	377 mW	145 mW
D-14	950 mW	7.6 mW/ $^\circ\text{C}$	608 mW	494 mW	190 mW
FK	1375 mW	11.0 mW/ $^\circ\text{C}$	880 mW	715 mW	275 mW
J	1375 mW	11.0 mW/ $^\circ\text{C}$	880 mW	715 mW	275 mW
JG	1050 mW	8.4 mW/ $^\circ\text{C}$	672 mW	546 mW	210 mW
N	1150 mW	9.2 mW/ $^\circ\text{C}$	736 mW	598 mW	230 mW
P	1000 mW	8.0 mW/ $^\circ\text{C}$	640 mW	520 mW	200 mW

recommended operating conditions

		C SUFFIX		I SUFFIX		M SUFFIX		UNIT
		MIN	MAX	MIN	MAX	MIN	MAX	
Supply voltage, V_{DD}		1.4	16	3	16	4	16	V
Common-mode input voltage, V_{IC}	$V_{DD} = 5$ V	-0.2	4	-0.2	4	0	4	V
	$V_{DD} = 10$ V	-0.2	9	-0.2	9	0	9	
Operating free-air temperature, T_A		0	70	-40	85	-55	125	$^\circ\text{C}$



electrical characteristics at specified free-air temperature

PARAMETER	TEST CONDITIONS	T _A †	TLC1078C						UNIT
			V _{DD} = 5 V			V _{DD} = 10 V			
			MIN	TYP	MAX	MIN	TYP	MAX	
V _{IO}	Input offset voltage	V _O = 1.4 V, R _S = 50 Ω , V _{IC} = 0, R _I = 1 M Ω	25°C	160	450		180	600	μ V
α V _{IO}	Temperature coefficient of input offset voltage		Full range		800			950	μ V/°C
I _{IO}	Input offset current (see Note 4)	V _O = V _{DD} /2, V _{IC} = V _{DD} /2	25°C	0.1	60		0.1	60	pA
I _{IB}	Input bias current (see Note 4)		70°C	7	300		7	300	pA
			25°C	0.6	60		0.7	60	pA
			70°C	40	600		50	600	pA
V _{ICR}	Common-mode input voltage range (see Note 5)		25°C	-0.2 to 4	-0.3 to 4.2		-0.2 to 9	-0.3 to 9.2	V
			Full range	-0.2 to 3.5			-0.2 to 8.5		V
V _{OH}	High-level output voltage	V _{ID} = 100 mV, R _L = 1 M Ω	25°C	3.2	4.1		8.2	8.9	V
			0°C	3.2	4.1		8.2	8.9	V
			70°C	3.2	4.2		8.2	8.9	V
V _{OL}	Low-level output voltage	V _{ID} = -100 mV, I _{OL} = 0	25°C	0	25		0	25	mV
			0°C	0	25		0	25	mV
			70°C	0	25		0	25	mV
A _{VD}	Large-signal differential voltage amplification	R _L = 1 M Ω , See Note 6	25°C	250	525		500	850	V/mV
			0°C	250	680		500	1010	V/mV
			70°C	200	380		350	660	V/mV
CMRR	Common-mode rejection ratio	V _{IC} = V _{ICRmin}	25°C	70	95		75	97	dB
			0°C	70	95		75	97	dB
			70°C	70	95		75	97	dB
k _{SVR}	Supply-voltage rejection ratio (Δ V _{DD} / Δ V _{IO})	V _O = 1.4 V	25°C	75	98		75	98	dB
			0°C	75	98		75	98	dB
			70°C	75	98		75	98	dB
I _{DD}	Supply current (two amplifiers)	V _O = V _{DD} /2, V _{IC} = V _{DD} /2, No load	25°C	20	34		29	46	μ A
			0°C	24	42		36	66	μ A
			70°C	16	28		22	40	μ A

† Full range is 0°C to 70°C.

- NOTES: 4. The typical values of input bias current and input offset current below 5 pA were determined mathematically.
 5. This range also applies to each input individually.
 6. At V_{DD} = 5 V, V_O = 0.25 V to 2 V; at V_{DD} = 10 V, V_O = 1 V to 6 V.

TLC1078, TLC1078Y, TLC1079, TLC1079Y
LinCMOS™ μ POWER PRECISION
OPERATIONAL AMPLIFIERS

SLOS179A – FEBRUARY 1997 – REVISED MARCH 2001

electrical characteristics at specified free-air temperature

PARAMETER	TEST CONDITIONS	T_A †	TLC1079C						UNIT
			$V_{DD} = 5\text{ V}$			$V_{DD} = 10\text{ V}$			
			MIN	TYP	MAX	MIN	TYP	MAX	
V_{IO} Input offset voltage	$V_O = 1.4\text{ V}, V_{IC} = 0,$ $R_S = 50\ \Omega, R_I = 1\text{ M}\Omega$	25°C	190	850		200	1150	μV	
		Full range		1200			1500		
α_{VIO} Temperature coefficient of input offset voltage		25°C to 70°C	1.1			1			$\mu\text{V}/^\circ\text{C}$
I_{IO} Input offset current (see Note 4)	$V_O = V_{DD}/2,$ $V_{IC} = V_{DD}/2$	25°C	0.1	60		0.1	60	pA	
		70°C	7	300		7	300		
I_{IB} Input bias current (see Note 4)		25°C	0.6	60		0.7	60	pA	
		70°C	40	600		50	600		
V_{ICR} Common mode input voltage range (see Note 5)		25°C	-0.2 to 4	-0.3 to 4.2		-0.2 to 9	-0.3 to 9.2	V	
		Full range	-0.2 to 3.5			-0.2 to 8.5		V	
V_{OH} High-level output voltage	$V_{ID} = 100\text{ mV},$ $R_L = 1\text{ M}\Omega$	25°C	3.2	4.1		8.2	8.9	V	
		0°C	3.2	4.1		8.2	8.9		
		70°C	3.2	4.2		8.2	8.9		
V_{OL} Low-level output voltage	$V_{ID} = -100\text{ mV},$ $I_{OL} = 0$	25°C	0	25		0	25	mV	
		0°C	0	25		0	25		
		70°C	0	25		0	25		
A_{VD} Large-signal differential voltage amplification	$R_L = 1\text{ M}\Omega,$ See Note 6	25°C	250	525		500	850	V/mV	
		0°C	250	700		500	1010		
		70°C	200	380		350	660		
CMRR Common mode rejection ratio	$V_{IC} = V_{ICRmin}$	25°C	70	95		75	97	dB	
		0°C	70	95		75	97		
		70°C	70	95		75	97		
k_{SVR} Supply-voltage rejection ratio ($\Delta V_{DD}/\Delta V_{IO}$)	$V_{DD} = 5\text{ V to }10\text{ V},$ $V_O = 1.4\text{ V}$	25°C	75	98		75	98	dB	
		0°C	75	98		75	98		
		70°C	75	98		75	98		
I_{DD} Supply current (four amplifiers)	$V_O = V_{DD}/2,$ $V_{IC} = V_{DD}/2,$ No load	25°C	40	68		57	92	μA	
		0°C	48	84		72	132		
		70°C	31	56		44	80		

† Full range is 0°C to 70°C.

- NOTES: 4. The typical values of input bias current and input offset current below 5 pA were determined mathematically.
 5. This range also applies to each input individually.
 6. At $V_{DD} = 5\text{ V}, V_O = 0.25\text{ V to }2\text{ V};$ at $V_{DD} = 10\text{ V}, V_O = 1\text{ V to }6\text{ V}.$



operating characteristics at specified free-air temperature

PARAMETER	TEST CONDITIONS	T _A	TLC1078C						UNIT
			V _{DD} = 5 V			V _{DD} = 10 V			
			MIN	TYP	MAX	MIN	TYP	MAX	
SR Slew rate at unity gain	R _L = 1 M Ω , C _L = 20 pF, V _{I(PP)} = 1 V, See Figure 1	25°C	32			47			V/ms
		0°C	35			51			
		70°C	27			38			
V _n Equivalent input noise voltage	f = 1 kHz, R _S = 20 Ω	25°C	68			68			nV/ $\sqrt{\text{Hz}}$
B ₁ Unity-gain bandwidth	C _L = 20 pF, See Figure 2	25°C	85			110			kHz
		0°C	100			125			
		70°C	65			90			
ϕ_m Phase margin at unity gain	C _L = 20 pF, See Figure 2	25°C	34°			38°			
		0°C	36°			40°			
		70°C	30°			34°			

operating characteristics at specified free-air temperature

PARAMETER	TEST CONDITIONS	T _A	TLC1079C						UNIT
			V _{DD} = 5 V			V _{DD} = 10 V			
			MIN	TYP	MAX	MIN	TYP	MAX	
SR Slew rate at unity gain	R _L = 1 M Ω , C _L = 20 pF, V _{I(PP)} = 1 V, See Figure 1	25°C	32			47			V/ms
		0°C	35			51			
		70°C	27			38			
V _n Equivalent input noise voltage	f = 1 kHz, R _S = 20 Ω	25°C	68			68			nV/ $\sqrt{\text{Hz}}$
B ₁ Unity-gain bandwidth	C _L = 20 pF, See Figure 2	25°C	85			110			kHz
		0°C	100			125			
		70°C	65			90			
ϕ_m Phase margin at unity gain	C _L = 20 pF, See Figure 2	25°C	34°			38°			
		0°C	36°			40°			
		70°C	30°			34°			

TLC1078, TLC1078Y, TLC1079, TLC1079Y
LinCMOS™ μ POWER PRECISION
OPERATIONAL AMPLIFIERS

SLOS179A – FEBRUARY 1997 – REVISED MARCH 2001

electrical characteristics at specified free-air temperature

PARAMETER	TEST CONDITIONS	T _A †	TLC1078I						UNIT
			V _{DD} = 5 V			V _{DD} = 10 V			
			MIN	TYP	MAX	MIN	TYP	MAX	
V _{IO}	Input offset voltage	V _O = 1.4 V, R _S = 50 Ω, V _{IC} = 0, R _I = 1 MΩ	25°C	160	450	180	600	μV	
	Full range			950		1100			
α _{VIO}	Temperature coefficient of input offset voltage	25°C to 85°C		1.1		1		μV/°C	
I _{IO}	Input offset current (see Note 4)	V _O = V _{DD} /2, V _{IC} = V _{DD} /2	25°C	0.1	60	0.1	60	pA	
			85°C	24	1000	26	1000		
I _{IB}	Input bias current (see Note 4)		25°C	0.6	60	0.7	60	pA	
			85°C	200	2000	220	2000		
V _{ICR}	Common-mode input voltage range (see Note 5)	25°C	-0.2 to 4	-0.3 to 4.2	-0.2 to 9	-0.3 to 9.2		V	
		Full range	-0.2 to 3.5		-0.2 to 8.5			V	
V _{OH}	High-level output voltage	V _{ID} = 100 mV, R _L = 1 MΩ	25°C	3.2	4.1	8.2	8.9	V	
			-40°C	3.2	4.1	8.2	8.9		
			85°C	3.2	4.2	8.2	8.9		
V _{OL}	Low-level output voltage	V _{ID} = -100 mV, I _{OL} = 0	25°C	0	25	0	25	mV	
			-40°C	0	25	0	25		
			85°C	0	25	0	25		
A _{VD}	Large-signal differential voltage amplification	R _L = 1 MΩ, See Note 6	25°C	250	525	500	850	V/mV	
			-40°C	250	900	500	1550		
			85°C	150	300	250	585		
CMRR	Common-mode rejection ratio	V _{IC} = V _{ICRmin}	25°C	70	95	75	97	dB	
			-40°C	70	95	75	97		
			85°C	70	95	75	97		
k _{SVR}	Supply-voltage rejection ratio (ΔV _{DD} /ΔV _{IO})	V _O = 1.4 V	25°C	75	98	75	98	dB	
			-40°C	75	98	75	98		
			85°C	75	98	75	98		
I _{DD}	Supply current (two amplifiers)	V _O = V _{DD} /2, V _{IC} = V _{DD} /2, No load	25°C	20	34	29	46	μA	
			-40°C		31	54	50		86
			85°C		15	26	20		36

† Full range is -40°C to 80°C.

- NOTES: 4. The typical values of input bias current and input offset current below 5 pA were determined mathematically.
5. This range also applies to each input individually.
6. At V_{DD} = 5 V, V_O = 0.25 V to 2 V; at V_{DD} = 10 V, V_O = 1 V to 6 V.



electrical characteristics at specified free-air temperature

PARAMETER	TEST CONDITIONS	T _A †	TLC1079I						UNIT
			V _{DD} = 5 V			V _{DD} = 10 V			
			MIN	TYP	MAX	MIN	TYP	MAX	
V _{IO} Input offset voltage	V _O = 1.4 V, V _{IC} = 0, R _S = 50 Ω, R _I = 1 MΩ	25°C		190	850		200	1150	μV
		Full range			1350			1650	
α _{VIO} Temperature coefficient of input offset voltage		25°C to 85°C		1.1			1		μV/°C
I _{IO} Input offset current (see Note 4)	V _O = V _{DD} / 2, V _{IC} = V _{DD} / 2	25°C		0.1	60		0.1	60	pA
		85°C		24	1000		26	1000	
I _{IB} Input bias current (see Note 4)		25°C		0.6	60		0.7	60	pA
		85°C		200	2000		220	2000	
V _{ICR} Common-mode input voltage range (see Note 5)		25°C	-0.2 to 4	-0.3 to 4.2		-0.2 to 9	-0.3 to 9.2		V
		Full range	-0.2 to 3.5			-0.2 to 8.5			V
V _{OH} High-level output voltage	V _{ID} = 100 mV, R _L = 1 MΩ	25°C	3.2	4.1		8.2	8.9		V
		-40°C	3.2	4.1		8.2	8.9		
		85°C	3.2	4.2		8.2	8.9		
V _{OL} Low-level output voltage	V _{ID} = -100 mV, I _{OL} = 0	25°C		0	25		0	25	mV
		-40°C		0	25		0	25	
		85°C		0	25		0	25	
A _{VD} Large-signal differential voltage amplification	R _L = 1 MΩ, See Note 6	25°C	250	525		500	850		V/mV
		-40°C	250	900		500	1550		
		85°C	150	330		250	585		
CMRR Common-mode rejection ratio	V _{IC} = V _{ICRmin}	25°C	70	95		75	97		dB
		-40°C	70	95		75	97		
		85°C	70	95		75	97		
k _{SVR} Supply-voltage rejection ratio (ΔV _{DD} /ΔV _{IO})	V _{DD} = 5 V to 10 V, V _O = 1.4 V	25°C	75	98		75	98		dB
		-40°C	75	98		75	98		
		85°C	75	98		75	98		
I _{DD} Supply current (four amplifiers)	V _O = V _{DD} / 2, V _{IC} = V _{DD} / 2, No load	25°C		40	68		57	92	μA
		-40°C		62	108		98	172	
		85°C		29	52		40	72	

† Full range is -40°C to 85°C.

- NOTES: 4. The typical values of input bias current and input offset current below 5 pA were determined mathematically.
 5. This range also applies to each input individually.
 6. At V_{DD} = 5 V, V_O = 0.25 V to 2 V; at V_{DD} = 10 V, V_O = 1 V to 6 V.

TLC1078, TLC1078Y, TLC1079, TLC1079Y
LinCMOS™ μ POWER PRECISION
OPERATIONAL AMPLIFIERS

SLOS179A – FEBRUARY 1997 – REVISED MARCH 2001

operating characteristics at specified free-air temperature

PARAMETER	TEST CONDITIONS	T _A	TLC1078I						UNIT
			V _{DD} = 5 V			V _{DD} = 10 V			
			MIN	TYP	MAX	MIN	TYP	MAX	
SR Slew rate at unity gain	R _L = 1 M Ω , C _L = 20 pF, V _{I(PP)} = 1 V, See Figure 1	25°C	32			47			V/ms
		-40°C	39			59			
		85°C	25			34			
V _n Equivalent input noise voltage	f = 1 kHz, R _S = 20 Ω	25°C	68			68			nV/ $\sqrt{\text{Hz}}$
B ₁ Unity-gain bandwidth	C _L = 20 pF, See Figure 2	25°C	85			110			kHz
		-40°C	130			155			
		85°C	55			80			
ϕ_m Phase margin at unity gain	C _L = 20 pF, See Figure 2	25°C	34°			38°			
		-40°C	38°			40°			
		85°C	28°			32°			

operating characteristics at specified free-air temperature

PARAMETER	TEST CONDITIONS	T _A	TLC1079I						UNIT
			V _{DD} = 5 V			V _{DD} = 10 V			
			MIN	TYP	MAX	MIN	TYP	MAX	
SR Slew rate at unity gain	R _L = 1 M Ω , C _L = 20 pF, V _{I(PP)} = 1 V, See Figure 1	25°C	32			47			V/ms
		-40°C	39			59			
		85°C	25			34			
V _n Equivalent input noise voltage	f = 1 kHz, R _S = 20 Ω	25°C	68			68			nV/ $\sqrt{\text{Hz}}$
B ₁ Unity-gain bandwidth	C _L = 20 pF, See Figure 2	25°C	85			110			kHz
		-40°C	130			155			
		85°C	55			80			
ϕ_m Phase margin at unity gain	C _L = 20 pF, See Figure 2	25°C	34°			38°			
		-40°C	38°			42°			
		85°C	28°			32°			



TLC1078, TLC1078Y, TLC1079, TLC1079Y
 LinCMOS™ μ POWER PRECISION
 OPERATIONAL AMPLIFIERS

SLOS179A – FEBRUARY 1997 – REVISED MARCH 2001

electrical characteristics at specified operating free-air temperature

PARAMETER	TEST CONDITIONS	T _A †	TLC1078M						UNIT
			V _{DD} = 5 V			V _{DD} = 10 V			
			MIN	TYP	MAX	MIN	TYP	MAX	
V _{IO} Input offset voltage	V _O = 1.4 V, V _{IC} = 0, R _S = 50 Ω , R _L = 1 M Ω	25°C	160		450	180		600	μ V
		Full range	1250			1400			
α _{VIO} Temperature coefficient of input offset voltage		25°C to 125°C	1.4			1.4			μ V/°C
I _{IO} Input offset current (see Note 4)	V _O = V _{DD} /2, V _{IC} = V _{DD} /2	25°C	0.1	60		0.1	60		pA
		125°C	1.4	15		1.8	15		nA
I _{IB} Input bias current (see Note 4)		25°C	0.6	60		0.7	60		pA
		125°C	9	35		10	35		nA
V _{ICR} Common-mode input voltage range (see Note 5)		25°C	0 to 4	-0.3 to 4.2		0 to 9	-0.3 to 9.2		V
		Full range	0 to 3.5			0 to 8.5			V
V _{OH} High-level output voltage	V _{ID} = 100 mV, R _L = 1 M Ω	25°C	3.2	4.1		8.2	8.9		V
		-55°C	3.2	4.1		8.2	8.8		
		125°C	3.2	4.2		8.2	9		
V _{OL} Low-level output voltage	V _{ID} = -100 mV, I _{OL} = 0	25°C		0	25		0	25	mV
		-55°C		0	25		0	25	
		125°C		0	25		0	25	
A _{VD} Large-signal differential voltage amplification	R _L = 1 M Ω , See Note 6	25°C	250	525		500	850		V/mV
		-55°C	250	950		500	1750		
		125°C	35	200		75	380		
CMRR Common-mode rejection ratio	V _{IC} = V _{ICRmin}	25°C	70	95		75	97		dB
		-55°C	70	95		75	97		
		125°C	70	85		75	91		
k _{SVR} Supply-voltage rejection ratio (Δ V _{DD} / Δ V _{IO})	V _O = 1.4 V	25°C	75	98		75	98		dB
		-55°C	70	98		70	98		
		125°C	70	98		70	98		
I _{DD} Supply current (two amplifiers)	V _O = V _{DD} /2, V _{IC} = V _{DD} /2, No load	25°C		20	34		29	46	μ A
		-55°C		35	60		56	96	
		125°C		14	24		18	30	

† Full range is -55°C to 125°C.

- NOTES: 4. The typical values of input bias current and input offset current below 5 pA were determined mathematically.
 5. This range also applies to each input individually.
 6. At V_{DD} = 5 V, V_O = 0.25 V to 2 V; at V_{DD} = 10 V, V_O = 1 V to 6 V.



TLC1078, TLC1078Y, TLC1079, TLC1079Y
LinCMOS™ μ POWER PRECISION
OPERATIONAL AMPLIFIERS

SLOS179A – FEBRUARY 1997 – REVISED MARCH 2001

electrical characteristics at specified free-air temperature

PARAMETER	TEST CONDITIONS	T_A †	TLC1079M						UNIT
			$V_{DD} = 5\text{ V}$			$V_{DD} = 10\text{ V}$			
			MIN	TYP	MAX	MIN	TYP	MAX	
V_{IO} Input offset voltage	$V_O = 1.4\text{ V}$, $V_{IC} = 0$, $R_S = 50\ \Omega$, $R_I = 1\text{ M}\Omega$	25°C	190		850	200		1150	μV
Full range				1600			1900		
α_{VIO} Temperature coefficient of input offset voltage		25°C to 125°C	1.4			1.4			$\mu\text{V}/^\circ\text{C}$
I_{IO} Input offset current (see Note 4)	$V_O = V_{DD}/2$, $V_{IC} = V_{DD}/2$	25°C	0.1	60		0.1	60		pA
		125°C	1.4	15		1.8	15		nA
I_{IB} Input bias current (see Note 4)		25°C	0.6	60		0.7	60		pA
		125°C	9	35		10	35		nA
V_{ICR} Common mode input voltage range (see Note 5)		25°C	0 to 4	-0.3 to 4.2		0 to 9	-0.3 to 9.2		V
		Full range	0 to 3.5			0 to 8.5			V
V_{OH} High-level output voltage	$V_{ID} = 100\text{ mV}$, $R_L = 1\text{ M}\Omega$	25°C	3.2	4.1		8.2	8.9		V
		-55°C	3.2	4.1		8.2	8.9		
		125°C	3.2	4.2		8.2	9		
V_{OL} Low-level output voltage	$V_{ID} = -100\text{ mV}$, $I_{OL} = 0$	25°C		0	25		0	25	mV
		-55°C		0	25		0	25	
		125°C		0	25		0	25	
A_{VD} Large-signal differential voltage amplification	$R_L = 1\text{ M}\Omega$, See Note 6	25°C	250	525		500	850		V/mV
		-55°C	250	950		500	1750		
		125°C	35	200		75	380		
CMRR Common-mode rejection ratio	$V_{IC} = V_{ICRmin}$	25°C	70	95		75	97		dB
		-55°C	70	95		75	97		
		125°C	70	85		75	91		
k_{SVR} Supply voltage rejection ratio ($\Delta V_{DD}/\Delta V_{IO}$)	$V_{DD} = 5\text{ V to }10\text{ V}$, $V_O = 1.4\text{ V}$	25°C	75	98		75	98		dB
		-55°C	70	98		70	98		
		125°C	70	98		70	98		
I_{DD} Supply current (four amplifiers)	$V_O = V_{DD}/2$, $V_{IC} = V_{DD}/2$, No load	25°C		40	68		57	92	μA
		-55°C		69	120		111	192	
		125°C		27	48		35	60	

† Full range is -55°C to 125°C.

NOTES: 4. The typical values of input bias current and input offset current below 5 pA were determined mathematically.

5. This range also applies to each input individually.

6. At $V_{DD} = 5\text{ V}$, $V_O = 0.25\text{ V to }2\text{ V}$; at $V_{DD} = 10\text{ V}$, $V_O = 1\text{ V to }6\text{ V}$.



operating characteristics at specified free-air temperature

PARAMETER	TEST CONDITIONS	T _A	TLC1078M						UNIT
			V _{DD} = 5 V			V _{DD} = 10 V			
			MIN	TYP	MAX	MIN	TYP	MAX	
SR Slew rate at unity gain	R _L = 1 M Ω , C _L = 20 pF, V _{I(PP)} = 1 V, See Figure 1	25°C		32			47	V/ms	
		-55°C		41			63		
		125°C		20			27		
V _n Equivalent input noise voltage	f = 1 kHz, R _S = 20 Ω	25°C		68			68	nV/ $\sqrt{\text{Hz}}$	
B ₁ Unity-gain bandwidth	C _L = 20 pF, See Figure 2	25°C		85			110	kHz	
		-55°C		140			165		
		125°C		45			70		
ϕ_m Phase margin at unity gain	C _L = 20 pF, See Figure 2	25°C		34°			38°		
		-55°C		39°			43°		
		125°C		25°			29°		

operating characteristics at specified free-air temperature

PARAMETER	TEST CONDITIONS	T _A	TLC1079M						UNIT
			V _{DD} = 5 V			V _{DD} = 10 V			
			MIN	TYP	MAX	MIN	TYP	MAX	
SR Slew rate at unity gain	R _L = 1 M Ω , C _L = 20 pF, V _{I(PP)} = 1 V, See Figure 1	25°C		32			47	V/ms	
		-55°C		41			63		
		125°C		20			27		
V _n Equivalent input noise voltage	f = 1 kHz, R _S = 20 Ω	25°C		68			68	nV/ $\sqrt{\text{Hz}}$	
B ₁ Unity-gain bandwidth	C _L = 20 pF, See Figure 2	25°C		85			110	kHz	
		-55°C		140			165		
		125°C		45			70		
		25°C		34°			38°		
ϕ_m Phase margin at unity gain	C _L = 20 pF, See Figure 2	-55°C		39°			43°		
		125°C		25°			29°		

PARAMETER MEASUREMENT INFORMATION

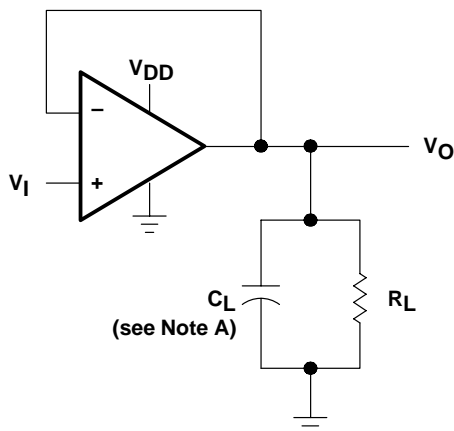

NOTE A: C_L includes fixture capacitance.

Figure 1. Slew-Rate Test Circuit

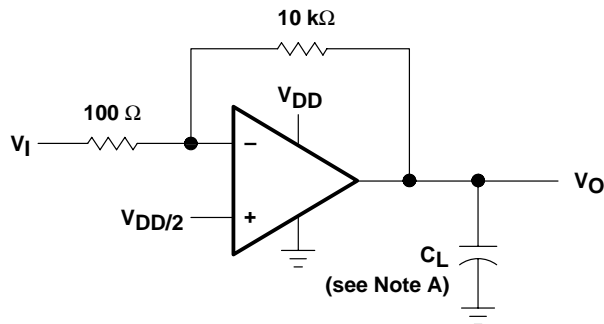

Figure 2. Unity-Gain Bandwidth and Phase-Margin Test Circuit

TYPICAL CHARACTERISTICS

Table of Graphs

		FIGURE
α_{VIO}	Temperature coefficient of input offset voltage	Distribution 3 – 6
I_{IB}	Input bias current	vs Free-air temperature 7
I_{IO}	Input offset current	vs Free-air temperature 7
V_{IC}	Common-mode input voltage	vs Supply voltage 8
V_{OH}	High-level output voltage	vs High-level output current 9, 10
		vs Supply voltage 11
		vs Free-air temperature 12
V_{OL}	Low-level output voltage	vs Common-mode input voltage 13, 14
		vs Differential input voltage 15
		vs Free-air temperature 16
		vs Low-level output current 17, 18
		vs Supply voltage 19
A_{VD}	Large-signal differential voltage amplification	vs Free-air temperature 20
		vs Frequency 21, 22
		vs Frequency 23
V_{OM}	Maximum peak output voltage	vs Frequency 23
		vs Supply voltage 24
I_{DD}	Supply current	vs Free-air temperature 25
		vs Free-air temperature 25
SR	Slew rate	vs Supply voltage 26
		vs Free-air temperature 27
		vs Free-air temperature 28
V_n	Equivalent input noise voltage	vs Free-air temperature 28
		vs Frequency 29
B_1	Unity-gain bandwidth	vs Frequency 29
		vs Supply voltage 30
ϕ_m	Phase margin	vs Free-air temperature 31
		vs Supply voltage 32
		vs Free-air temperature 33
		vs Capacitive load 34
	Phase shift	vs Frequency 21, 22

TYPICAL CHARACTERISTICS

DISTRIBUTION OF TLC1078
 INPUT OFFSET VOLTAGE
 TEMPERATURE COEFFICIENT

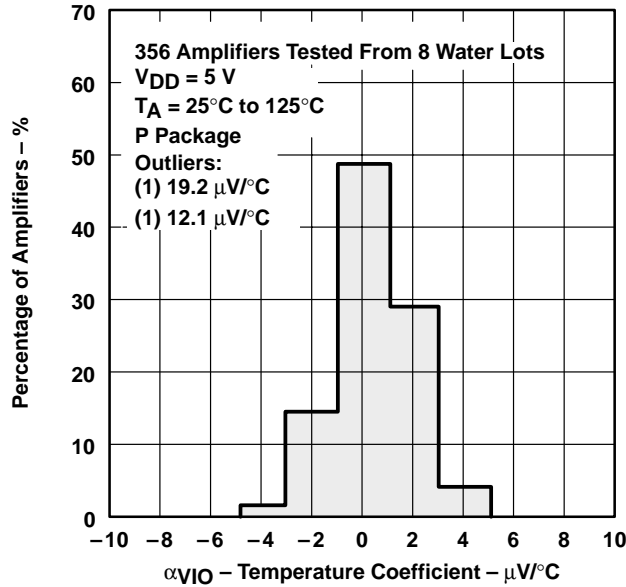

Figure 3

DISTRIBUTION OF TLC1078
 INPUT OFFSET VOLTAGE
 TEMPERATURE COEFFICIENT

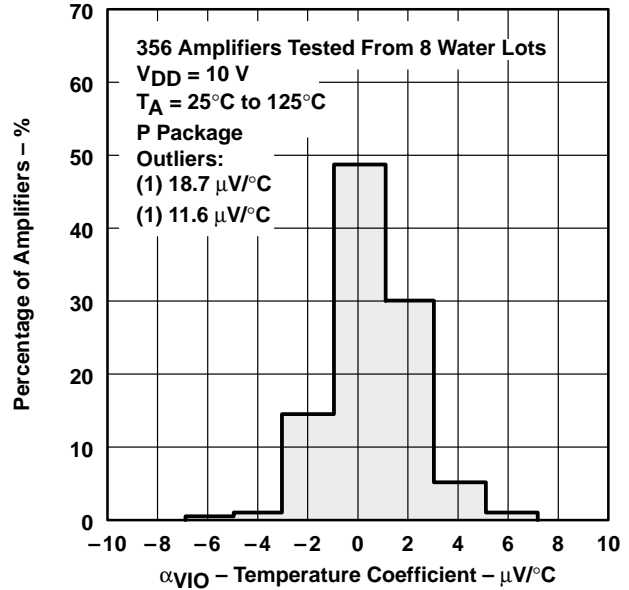

Figure 4

DISTRIBUTION OF TLC1079
 INPUT OFFSET VOLTAGE
 TEMPERATURE COEFFICIENT

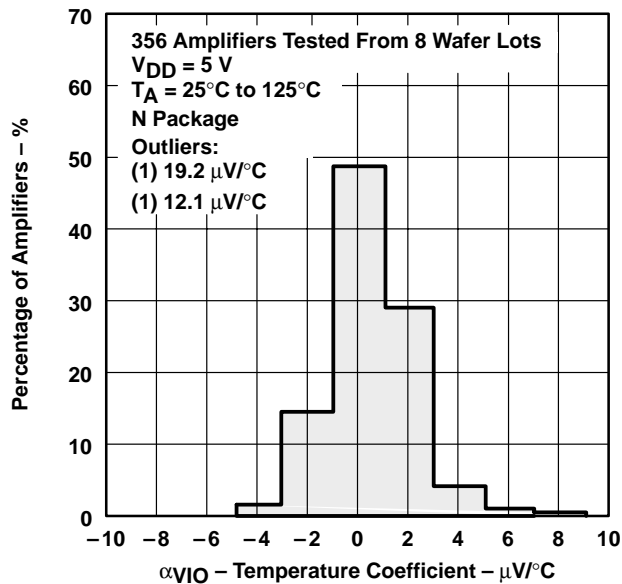

Figure 5

DISTRIBUTION OF TLC1079
 INPUT OFFSET VOLTAGE
 TEMPERATURE COEFFICIENT

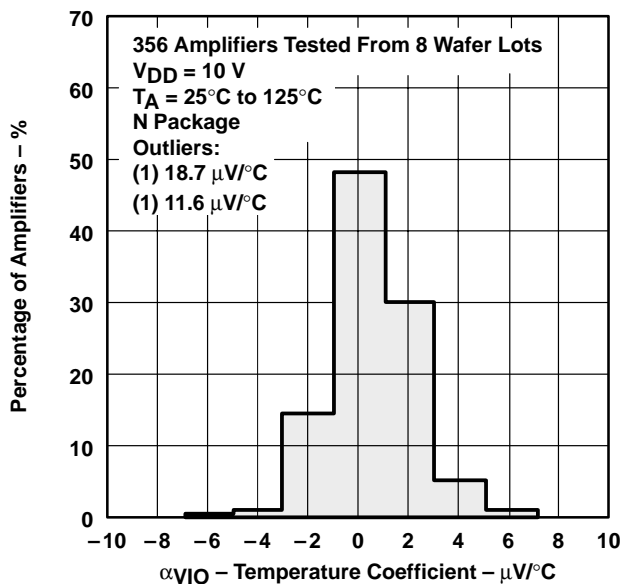
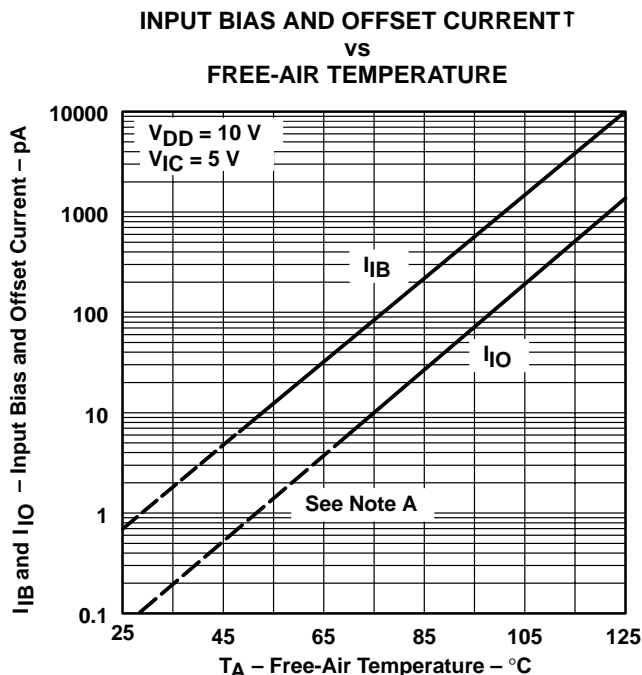

Figure 6

TYPICAL CHARACTERISTICS



NOTE A: The typical values of input bias current and input offset current below 5 pA were determined mathematically.

Figure 7

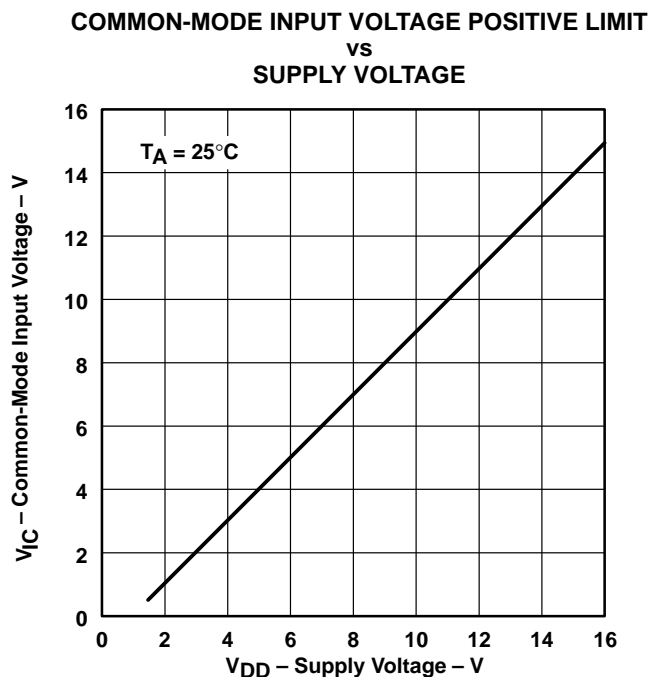

Figure 8

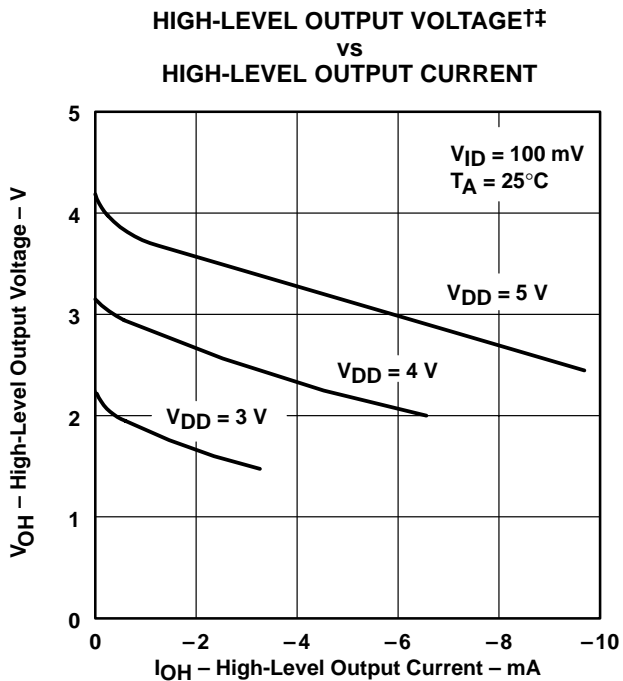

Figure 9

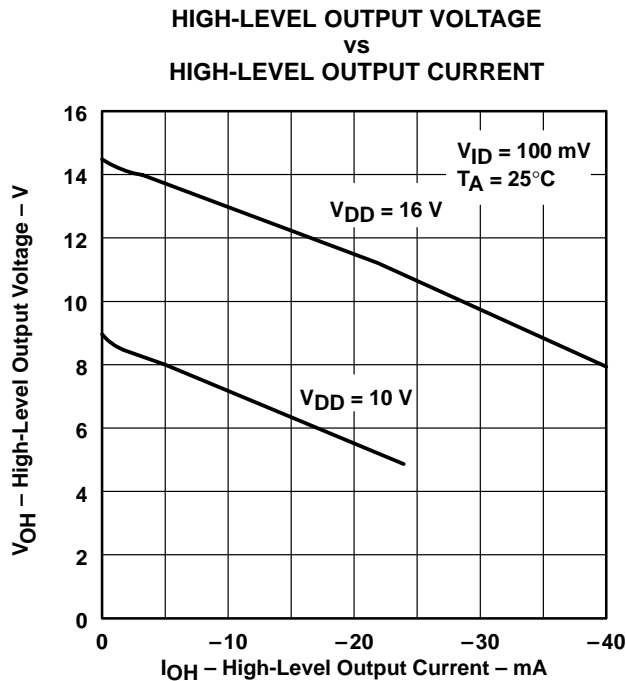

Figure 10

† Data at high and low temperatures are applicable only within the rated operating free-air temperature ranges of the various devices.
 † The $V_{DD} = 3\text{ V}$ curve does not apply to the TLC107xM.

TYPICAL CHARACTERISTICS

HIGH-LEVEL OUTPUT VOLTAGE
 vs
 SUPPLY VOLTAGE

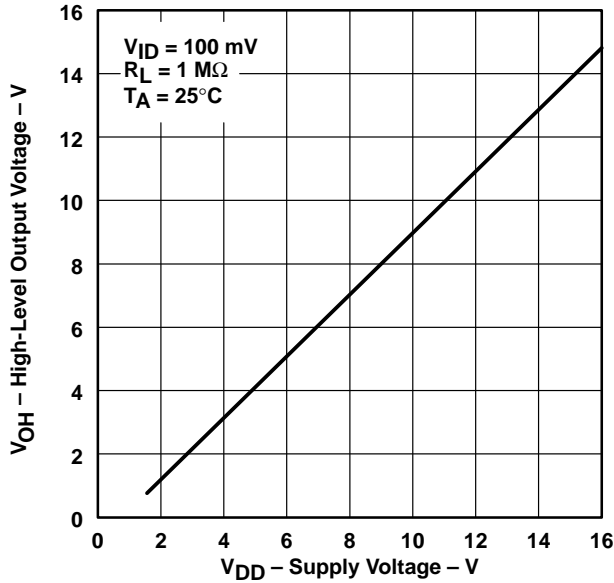

Figure 11

HIGH-LEVEL OUTPUT VOLTAGE†
 vs
 FREE-AIR TEMPERATURE

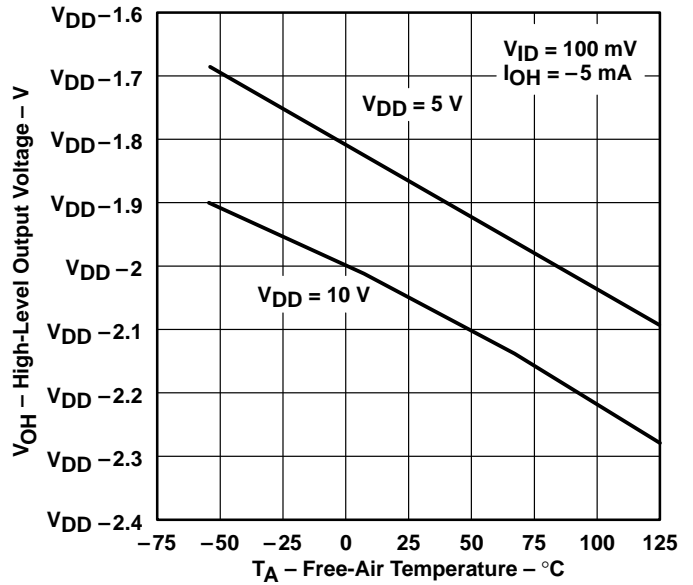

Figure 12

LOW-LEVEL OUTPUT VOLTAGE
 vs
 COMMON-MODE INPUT VOLTAGE

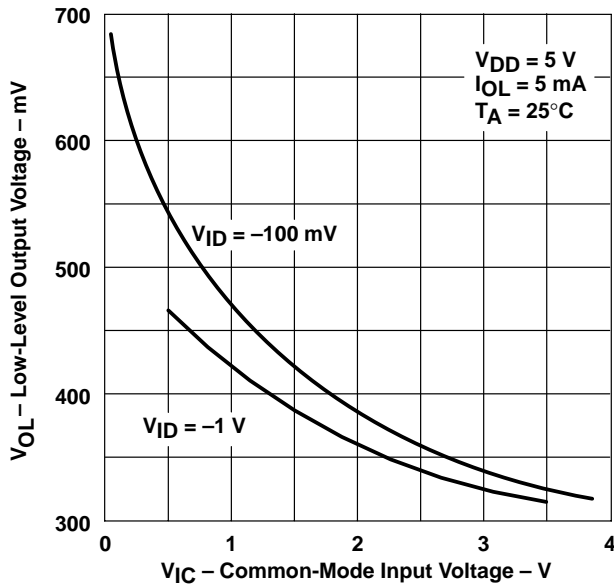

Figure 13

LOW-LEVEL OUTPUT VOLTAGE
 vs
 COMMON-MODE INPUT VOLTAGE

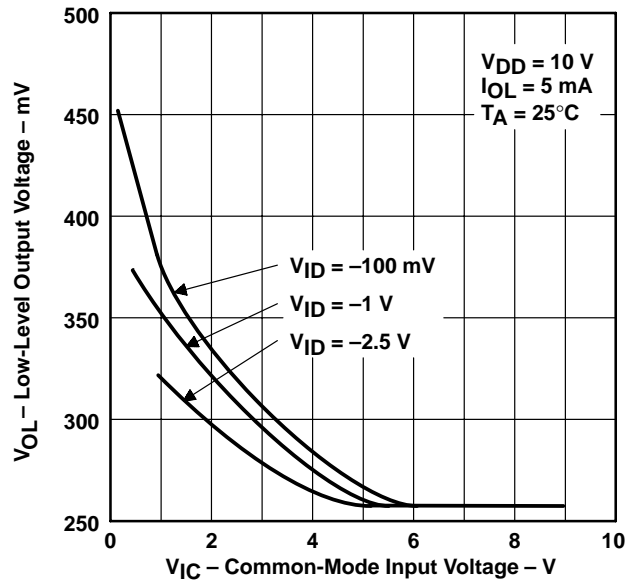

Figure 14

† Data at high and low temperatures are applicable only within the rated operating free-air temperature ranges of the various devices.

TYPICAL CHARACTERISTICS

LOW-LEVEL OUTPUT VOLTAGE
 vs
 DIFFERENTIAL INPUT VOLTAGE

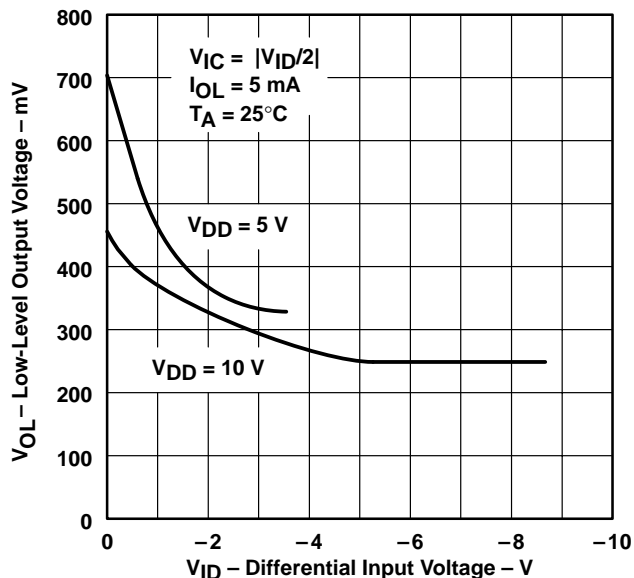

Figure 15

LOW-LEVEL OUTPUT VOLTAGE†
 vs
 FREE-AIR TEMPERATURE

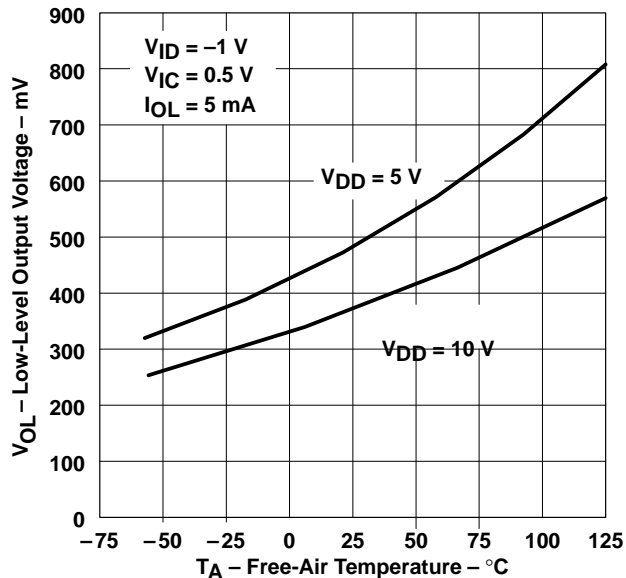

Figure 16

LOW-LEVEL OUTPUT VOLTAGE
 vs
 LOW-LEVEL OUTPUT CURRENT

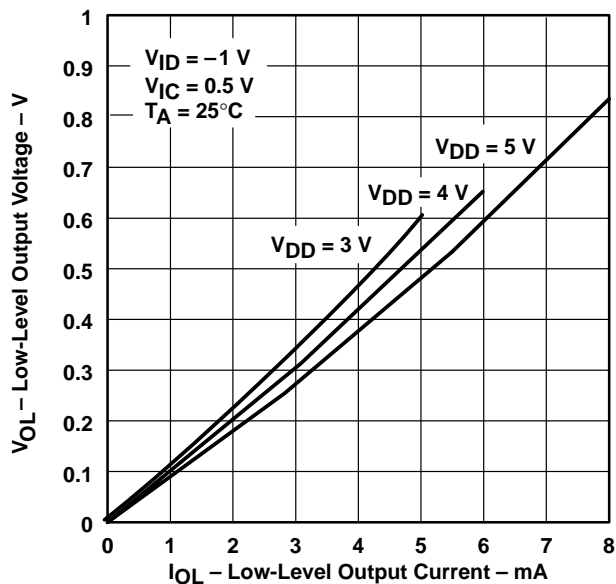

Figure 17

LOW-LEVEL OUTPUT VOLTAGE
 vs
 LOW-LEVEL OUTPUT CURRENT

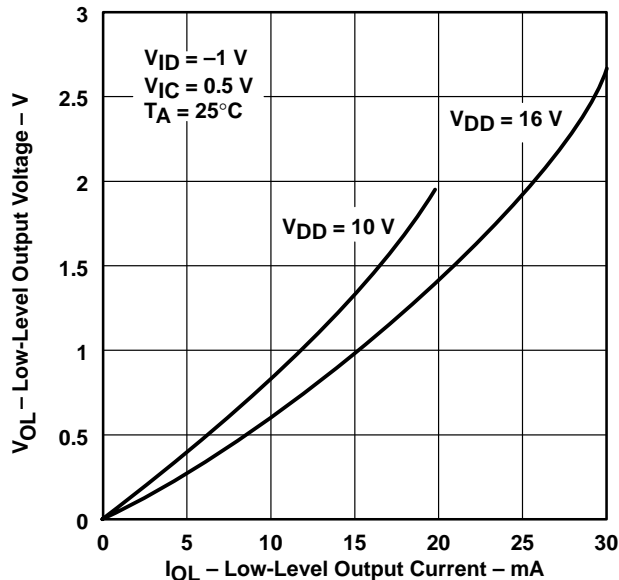

Figure 18

† Data at high and low temperatures are applicable only within the rated operating free-air temperature ranges of the various devices.

TYPICAL CHARACTERISTICS

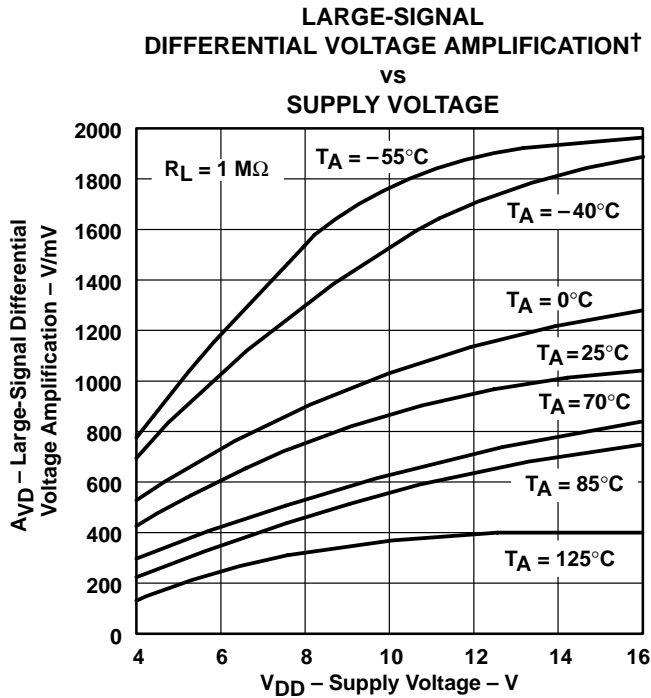

Figure 19

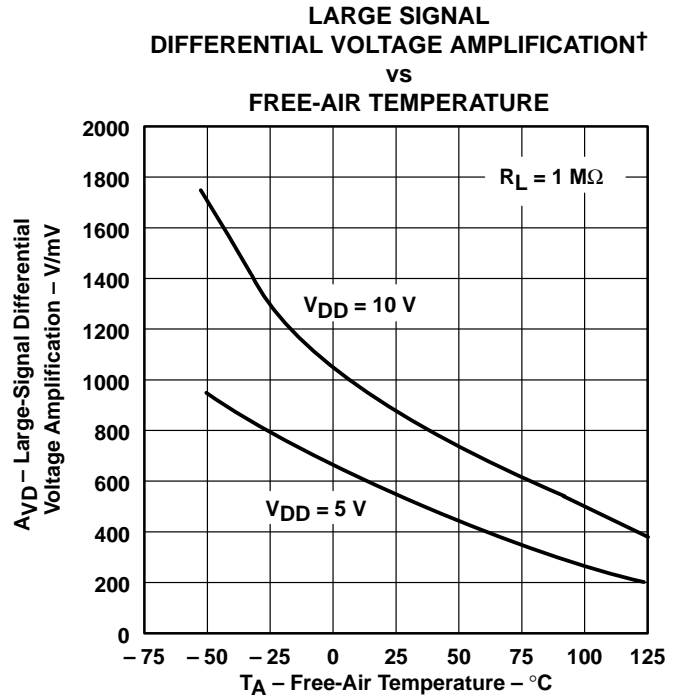

Figure 20

**LARGE-SIGNAL DIFFERENTIAL VOLTAGE
AMPLIFICATION AND PHASE SHIFT
vs
FREQUENCY**

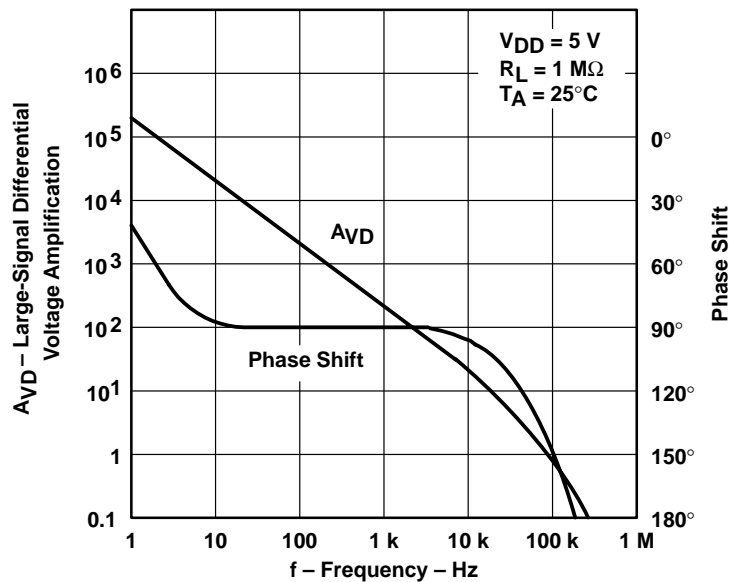

Figure 21

† Data at high and low temperatures are applicable only within the rated operating free-air temperature ranges of the various devices.

TYPICAL CHARACTERISTICS

LARGE-SIGNAL DIFFERENTIAL VOLTAGE
 AMPLIFICATION AND PHASE SHIFT
 VS
 FREQUENCY

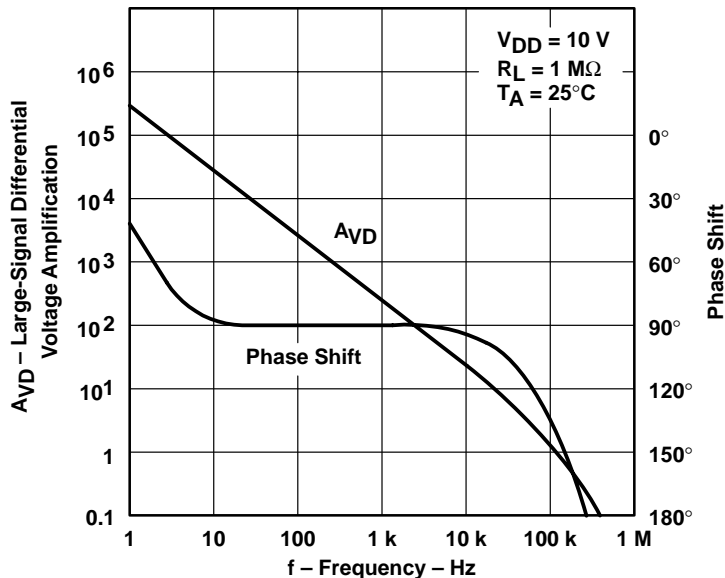

Figure 22

MAXIMUM PEAK OUTPUT VOLTAGE
 VS
 FREQUENCY

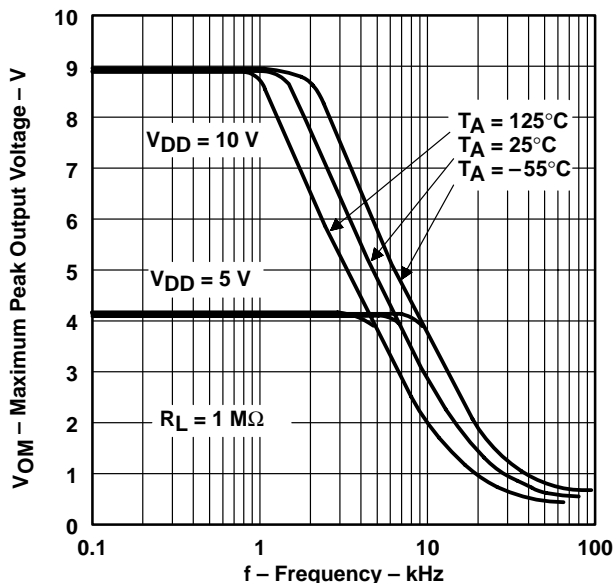

Figure 23

SUPPLY CURRENT†
 VS
 SUPPLY VOLTAGE

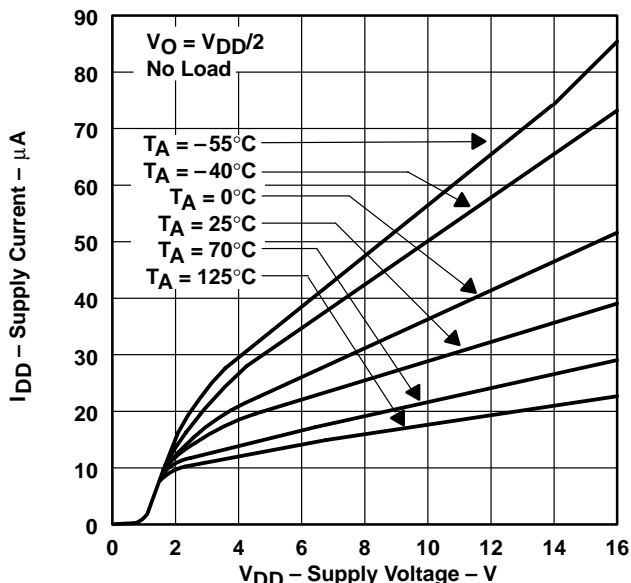
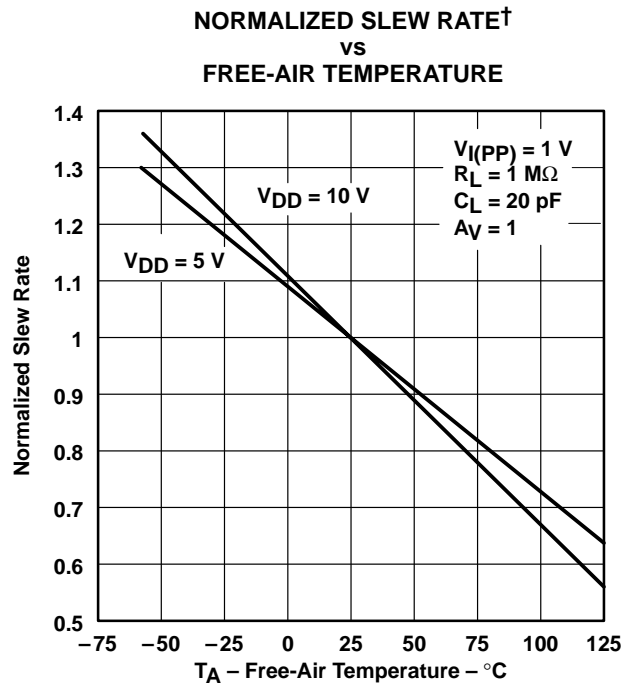
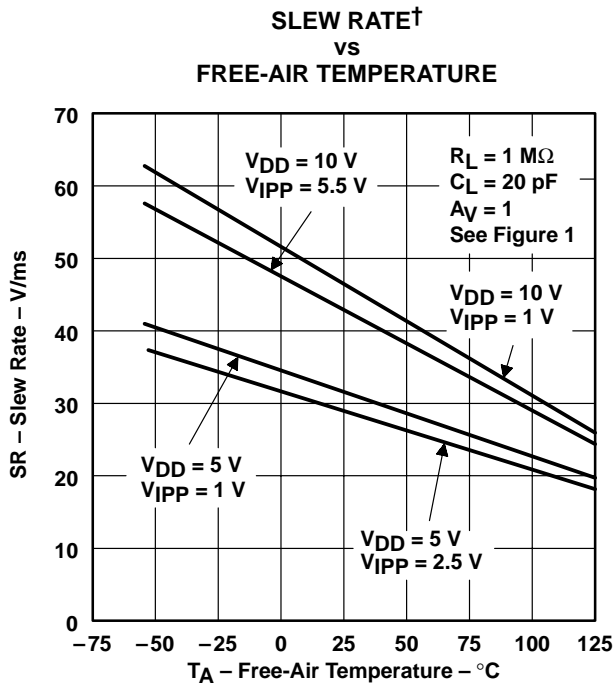
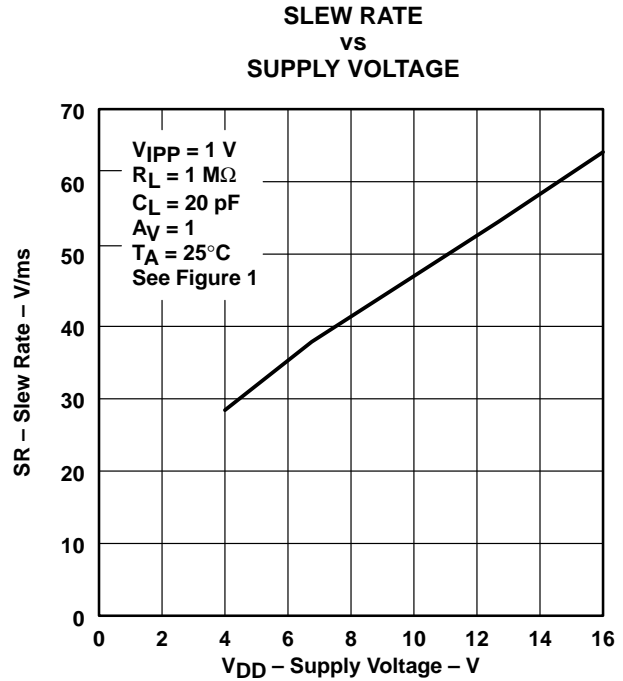
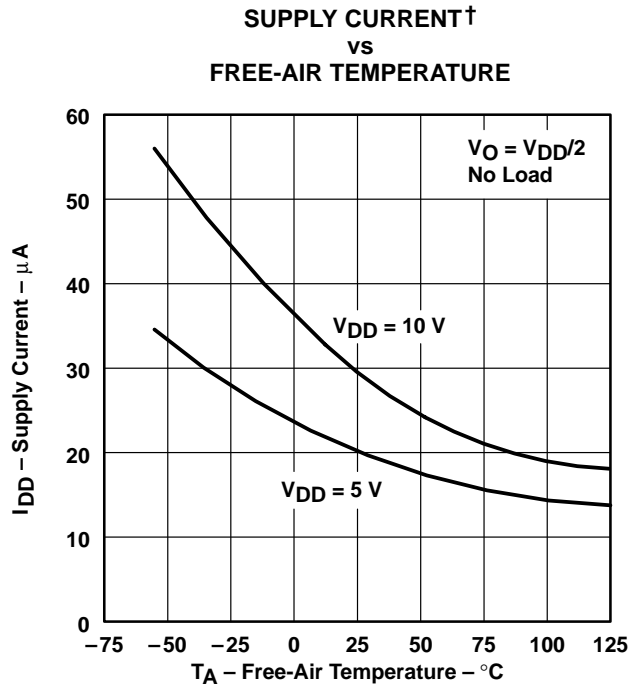

Figure 24

† Data at high and low temperatures are applicable only within the rated operating free-air temperature ranges of the various devices.

TYPICAL CHARACTERISTICS



† Data at high and low temperatures are applicable only within the rated operating free-air temperature ranges of the various devices.

TYPICAL CHARACTERISTICS

EQUIVALENT INPUT NOISE VOLTAGE
 VS
 FREQUENCY

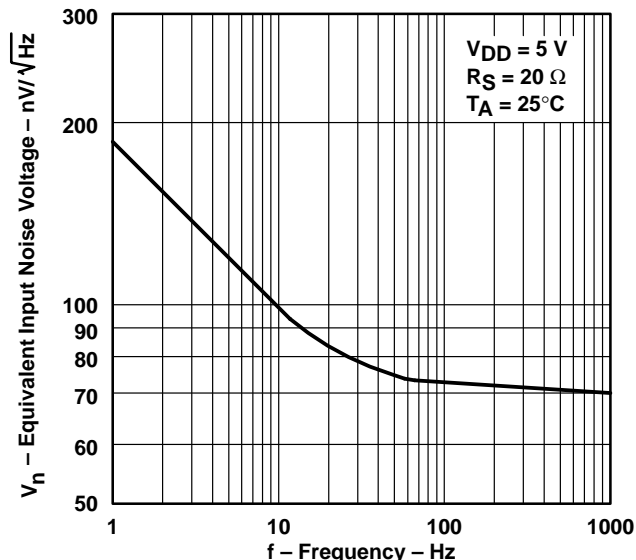

Figure 29

UNITY-GAIN BANDWIDTH
 VS
 SUPPLY VOLTAGE

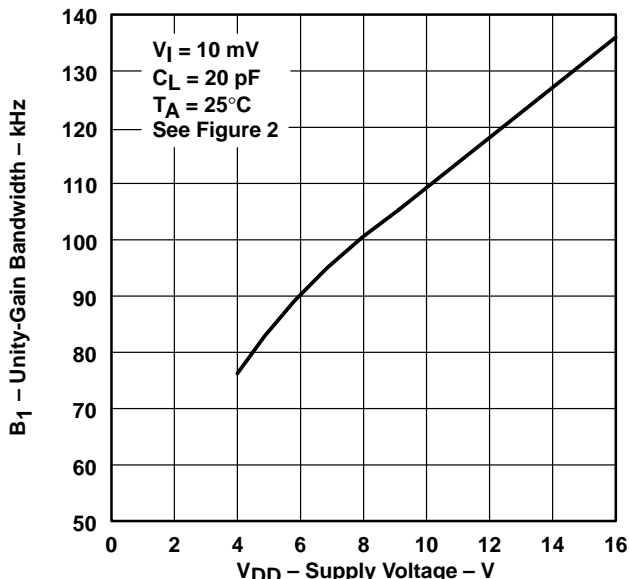

Figure 30

UNITY-GAIN BANDWIDTH†
 VS
 FREE-AIR TEMPERATURE

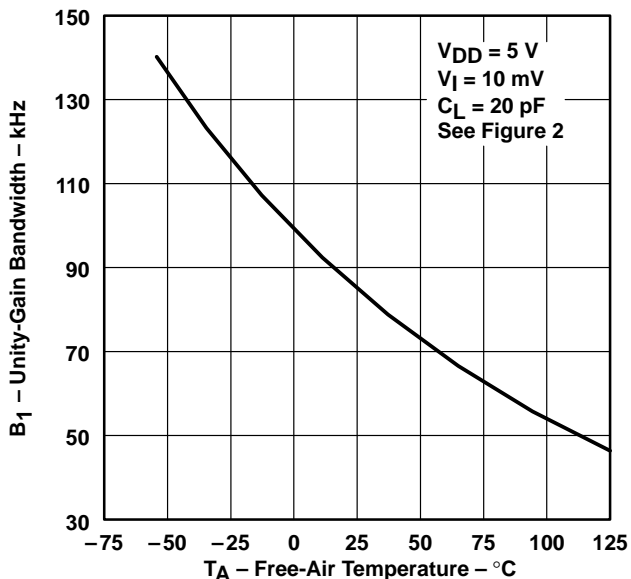

Figure 31

PHASE MARGIN
 VS
 SUPPLY VOLTAGE

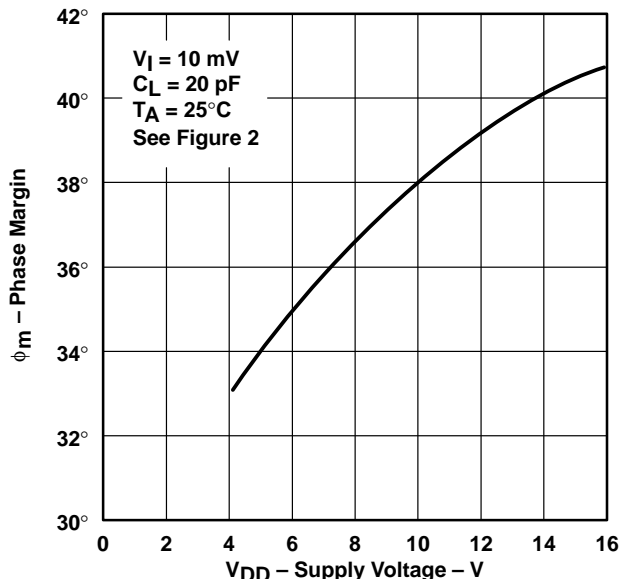

Figure 32

† Data at high and low temperatures are applicable only within the rated operating free-air temperature ranges of the various devices.

TYPICAL CHARACTERISTICS

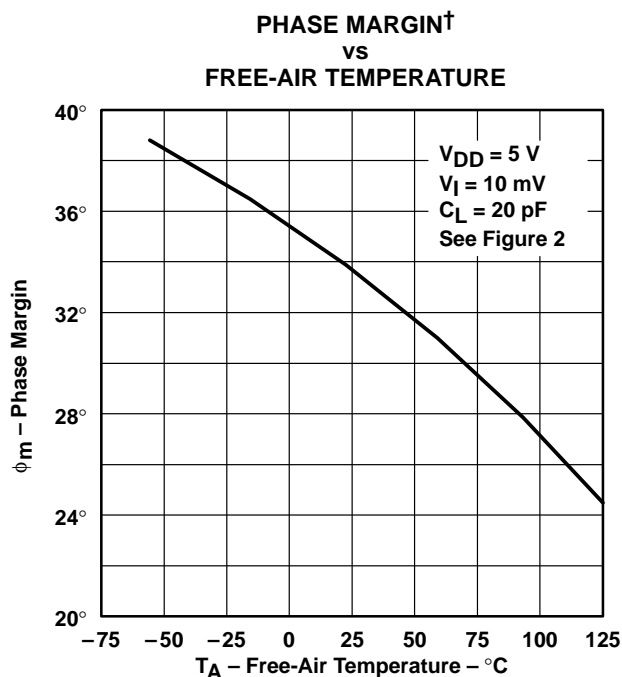

Figure 33

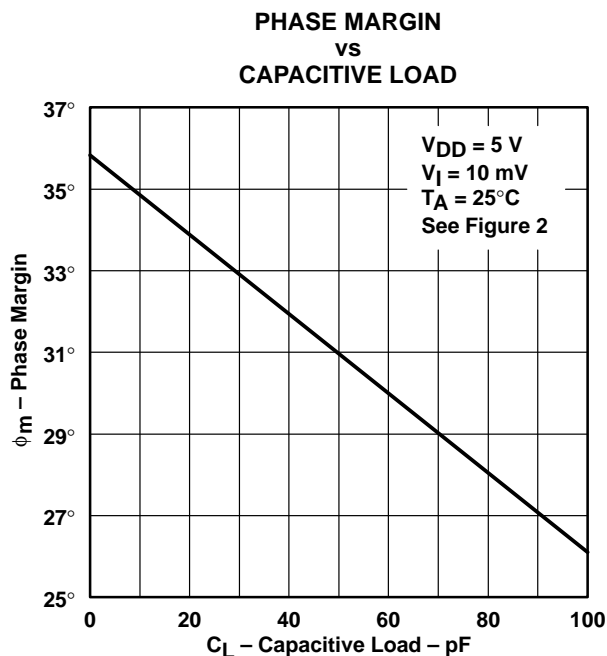

Figure 34

† Data at high and low temperatures are applicable only within the rated operating free-air temperature ranges of the various devices.

PACKAGING INFORMATION

Orderable Device	Status ⁽¹⁾	Package Type	Package Drawing	Pins	Package Qty	Eco Plan ⁽²⁾	Lead/ Ball Finish	MSL Peak Temp ⁽³⁾	Samples (Requires Login)
TLC1078CD	ACTIVE	SOIC	D	8	75	Green (RoHS & no Sb/Br)	CU NIPDAU	Level-1-260C-UNLIM	
TLC1078CDG4	ACTIVE	SOIC	D	8	75	Green (RoHS & no Sb/Br)	CU NIPDAU	Level-1-260C-UNLIM	
TLC1078CDR	ACTIVE	SOIC	D	8	2500	Green (RoHS & no Sb/Br)	CU NIPDAU	Level-1-260C-UNLIM	
TLC1078CDRG4	ACTIVE	SOIC	D	8	2500	Green (RoHS & no Sb/Br)	CU NIPDAU	Level-1-260C-UNLIM	
TLC1078CP	ACTIVE	PDIP	P	8	50	Pb-Free (RoHS)	CU NIPDAU	N / A for Pkg Type	
TLC1078CPE4	ACTIVE	PDIP	P	8	50	Pb-Free (RoHS)	CU NIPDAU	N / A for Pkg Type	
TLC1078ID	ACTIVE	SOIC	D	8	75	Green (RoHS & no Sb/Br)	CU NIPDAU	Level-1-260C-UNLIM	
TLC1078IDG4	ACTIVE	SOIC	D	8	75	Green (RoHS & no Sb/Br)	CU NIPDAU	Level-1-260C-UNLIM	
TLC1078IDR	ACTIVE	SOIC	D	8	2500	Green (RoHS & no Sb/Br)	CU NIPDAU	Level-1-260C-UNLIM	
TLC1078IDRG4	ACTIVE	SOIC	D	8	2500	Green (RoHS & no Sb/Br)	CU NIPDAU	Level-1-260C-UNLIM	
TLC1078IP	ACTIVE	PDIP	P	8	50	Pb-Free (RoHS)	CU NIPDAU	N / A for Pkg Type	
TLC1078IPE4	ACTIVE	PDIP	P	8	50	Pb-Free (RoHS)	CU NIPDAU	N / A for Pkg Type	
TLC1078MD	ACTIVE	SOIC	D	8		TBD	Call TI	Call TI	
TLC1078MDG4	ACTIVE	SOIC	D	8	75	Green (RoHS & no Sb/Br)	CU NIPDAU	Level-1-260C-UNLIM	
TLC1079CD	ACTIVE	SOIC	D	14	50	Green (RoHS & no Sb/Br)	CU NIPDAU	Level-1-260C-UNLIM	
TLC1079CDG4	ACTIVE	SOIC	D	14	50	Green (RoHS & no Sb/Br)	CU NIPDAU	Level-1-260C-UNLIM	
TLC1079CDR	ACTIVE	SOIC	D	14	2500	Green (RoHS & no Sb/Br)	CU NIPDAU	Level-1-260C-UNLIM	
TLC1079CDRG4	ACTIVE	SOIC	D	14	2500	Green (RoHS & no Sb/Br)	CU NIPDAU	Level-1-260C-UNLIM	
TLC1079CN	ACTIVE	PDIP	N	14	25	Pb-Free (RoHS)	CU NIPDAU	N / A for Pkg Type	
TLC1079CNE4	ACTIVE	PDIP	N	14	25	Pb-Free (RoHS)	CU NIPDAU	N / A for Pkg Type	

Orderable Device	Status ⁽¹⁾	Package Type	Package Drawing	Pins	Package Qty	Eco Plan ⁽²⁾	Lead/ Ball Finish	MSL Peak Temp ⁽³⁾	Samples (Requires Login)
TLC1079CNSR	ACTIVE	SO	NS	14	2000	Green (RoHS & no Sb/Br)	CU NIPDAU	Level-1-260C-UNLIM	
TLC1079CNSRG4	ACTIVE	SO	NS	14	2000	Green (RoHS & no Sb/Br)	CU NIPDAU	Level-1-260C-UNLIM	
TLC1079ID	ACTIVE	SOIC	D	14	50	Green (RoHS & no Sb/Br)	CU NIPDAU	Level-1-260C-UNLIM	
TLC1079IDG4	ACTIVE	SOIC	D	14	50	Green (RoHS & no Sb/Br)	CU NIPDAU	Level-1-260C-UNLIM	
TLC1079IDR	ACTIVE	SOIC	D	14	2500	Green (RoHS & no Sb/Br)	CU NIPDAU	Level-1-260C-UNLIM	
TLC1079IDRG4	ACTIVE	SOIC	D	14	2500	Green (RoHS & no Sb/Br)	CU NIPDAU	Level-1-260C-UNLIM	
TLC1079IN	ACTIVE	PDIP	N	14	25	Pb-Free (RoHS)	CU NIPDAU	N / A for Pkg Type	
TLC1079INE4	ACTIVE	PDIP	N	14	25	Pb-Free (RoHS)	CU NIPDAU	N / A for Pkg Type	

⁽¹⁾ The marketing status values are defined as follows:

ACTIVE: Product device recommended for new designs.

LIFEBUY: TI has announced that the device will be discontinued, and a lifetime-buy period is in effect.

NRND: Not recommended for new designs. Device is in production to support existing customers, but TI does not recommend using this part in a new design.

PREVIEW: Device has been announced but is not in production. Samples may or may not be available.

OBSELETE: TI has discontinued the production of the device.

⁽²⁾ Eco Plan - The planned eco-friendly classification: Pb-Free (RoHS), Pb-Free (RoHS Exempt), or Green (RoHS & no Sb/Br) - please check <http://www.ti.com/productcontent> for the latest availability information and additional product content details.

TBD: The Pb-Free/Green conversion plan has not been defined.

Pb-Free (RoHS): TI's terms "Lead-Free" or "Pb-Free" mean semiconductor products that are compatible with the current RoHS requirements for all 6 substances, including the requirement that lead not exceed 0.1% by weight in homogeneous materials. Where designed to be soldered at high temperatures, TI Pb-Free products are suitable for use in specified lead-free processes.

Pb-Free (RoHS Exempt): This component has a RoHS exemption for either 1) lead-based flip-chip solder bumps used between the die and package, or 2) lead-based die adhesive used between the die and leadframe. The component is otherwise considered Pb-Free (RoHS compatible) as defined above.

Green (RoHS & no Sb/Br): TI defines "Green" to mean Pb-Free (RoHS compatible), and free of Bromine (Br) and Antimony (Sb) based flame retardants (Br or Sb do not exceed 0.1% by weight in homogeneous material)

⁽³⁾ MSL, Peak Temp. -- The Moisture Sensitivity Level rating according to the JEDEC industry standard classifications, and peak solder temperature.

Important Information and Disclaimer: The information provided on this page represents TI's knowledge and belief as of the date that it is provided. TI bases its knowledge and belief on information provided by third parties, and makes no representation or warranty as to the accuracy of such information. Efforts are underway to better integrate information from third parties. TI has taken and continues to take reasonable steps to provide representative and accurate information but may not have conducted destructive testing or chemical analysis on incoming materials and chemicals. TI and TI suppliers consider certain information to be proprietary, and thus CAS numbers and other limited information may not be available for release.

In no event shall TI's liability arising out of such information exceed the total purchase price of the TI part(s) at issue in this document sold by TI to Customer on an annual basis.

TAPE AND REEL INFORMATION
REEL DIMENSIONS

TAPE DIMENSIONS

A0	Dimension designed to accommodate the component width
B0	Dimension designed to accommodate the component length
K0	Dimension designed to accommodate the component thickness
W	Overall width of the carrier tape
P1	Pitch between successive cavity centers

TAPE AND REEL INFORMATION

*All dimensions are nominal

Device	Package Type	Package Drawing	Pins	SPQ	Reel Diameter (mm)	Reel Width W1 (mm)	A0 (mm)	B0 (mm)	K0 (mm)	P1 (mm)	W (mm)	Pin1 Quadrant
TLC1078CDR	SOIC	D	8	2500	330.0	12.4	6.4	5.2	2.1	8.0	12.0	Q1
TLC1078IDR	SOIC	D	8	2500	330.0	12.4	6.4	5.2	2.1	8.0	12.0	Q1
TLC1078IDR	SOIC	D	8	2500	330.0	12.4	6.4	5.2	2.1	8.0	12.0	Q1
TLC1079CDR	SOIC	D	14	2500	330.0	16.4	6.5	9.0	2.1	8.0	16.0	Q1
TLC1079CNSR	SO	NS	14	2000	330.0	16.4	8.2	10.5	2.5	12.0	16.0	Q1
TLC1079IDR	SOIC	D	14	2500	330.0	16.4	6.5	9.0	2.1	8.0	16.0	Q1

TAPE AND REEL BOX DIMENSIONS

*All dimensions are nominal

Device	Package Type	Package Drawing	Pins	SPQ	Length (mm)	Width (mm)	Height (mm)
TLC1078CDR	SOIC	D	8	2500	340.5	338.1	20.6
TLC1078IDR	SOIC	D	8	2500	340.5	338.1	20.6
TLC1078IDR	SOIC	D	8	2500	367.0	367.0	35.0
TLC1079CDR	SOIC	D	14	2500	367.0	367.0	38.0
TLC1079CNSR	SO	NS	14	2000	367.0	367.0	38.0
TLC1079IDR	SOIC	D	14	2500	367.0	367.0	38.0

P (R-PDIP-T8)

PLASTIC DUAL-IN-LINE PACKAGE



- NOTES:
- A. All linear dimensions are in inches (millimeters).
 - B. This drawing is subject to change without notice.
 - C. Falls within JEDEC MS-001 variation BA.

N (R-PDIP-T**)

PLASTIC DUAL-IN-LINE PACKAGE

16 PINS SHOWN



- NOTES:
- A. All linear dimensions are in inches (millimeters).
 - B. This drawing is subject to change without notice.
 - C Falls within JEDEC MS-001, except 18 and 20 pin minimum body length (Dim A).
 - D The 20 pin end lead shoulder width is a vendor option, either half or full width.

4040049/E 12/2002

D (R-PDSO-G8)

PLASTIC SMALL OUTLINE



NOTES: A. All linear dimensions are in inches (millimeters).
 B. This drawing is subject to change without notice.
 C. Body length does not include mold flash, protrusions, or gate burrs. Mold flash, protrusions, or gate burrs shall not exceed 0.006 (0,15) each side.
 D. Body width does not include interlead flash. Interlead flash shall not exceed 0.017 (0,43) each side.
 E. Reference JEDEC MS-012 variation AA.

D (R-PDSO-G8)

PLASTIC SMALL OUTLINE



- NOTES:
- All linear dimensions are in millimeters.
 - This drawing is subject to change without notice.
 - Publication IPC-7351 is recommended for alternate designs.
 - Laser cutting apertures with trapezoidal walls and also rounding corners will offer better paste release. Customers should contact their board assembly site for stencil design recommendations. Refer to IPC-7525 for other stencil recommendations.
 - Customers should contact their board fabrication site for solder mask tolerances between and around signal pads.

MECHANICAL DATA

NS (R-PDSO-G)**

PLASTIC SMALL-OUTLINE PACKAGE

14-PINS SHOWN



- NOTES:
- A. All linear dimensions are in millimeters.
 - B. This drawing is subject to change without notice.
 - C. Body dimensions do not include mold flash or protrusion, not to exceed 0,15.

IMPORTANT NOTICE

Texas Instruments Incorporated and its subsidiaries (TI) reserve the right to make corrections, enhancements, improvements and other changes to its semiconductor products and services per JESD46, latest issue, and to discontinue any product or service per JESD48, latest issue. Buyers should obtain the latest relevant information before placing orders and should verify that such information is current and complete. All semiconductor products (also referred to herein as "components") are sold subject to TI's terms and conditions of sale supplied at the time of order acknowledgment.

TI warrants performance of its components to the specifications applicable at the time of sale, in accordance with the warranty in TI's terms and conditions of sale of semiconductor products. Testing and other quality control techniques are used to the extent TI deems necessary to support this warranty. Except where mandated by applicable law, testing of all parameters of each component is not necessarily performed.

TI assumes no liability for applications assistance or the design of Buyers' products. Buyers are responsible for their products and applications using TI components. To minimize the risks associated with Buyers' products and applications, Buyers should provide adequate design and operating safeguards.

TI does not warrant or represent that any license, either express or implied, is granted under any patent right, copyright, mask work right, or other intellectual property right relating to any combination, machine, or process in which TI components or services are used. Information published by TI regarding third-party products or services does not constitute a license to use such products or services or a warranty or endorsement thereof. Use of such information may require a license from a third party under the patents or other intellectual property of the third party, or a license from TI under the patents or other intellectual property of TI.

Reproduction of significant portions of TI information in TI data books or data sheets is permissible only if reproduction is without alteration and is accompanied by all associated warranties, conditions, limitations, and notices. TI is not responsible or liable for such altered documentation. Information of third parties may be subject to additional restrictions.

Resale of TI components or services with statements different from or beyond the parameters stated by TI for that component or service voids all express and any implied warranties for the associated TI component or service and is an unfair and deceptive business practice. TI is not responsible or liable for any such statements.

Buyer acknowledges and agrees that it is solely responsible for compliance with all legal, regulatory and safety-related requirements concerning its products, and any use of TI components in its applications, notwithstanding any applications-related information or support that may be provided by TI. Buyer represents and agrees that it has all the necessary expertise to create and implement safeguards which anticipate dangerous consequences of failures, monitor failures and their consequences, lessen the likelihood of failures that might cause harm and take appropriate remedial actions. Buyer will fully indemnify TI and its representatives against any damages arising out of the use of any TI components in safety-critical applications.

In some cases, TI components may be promoted specifically to facilitate safety-related applications. With such components, TI's goal is to help enable customers to design and create their own end-product solutions that meet applicable functional safety standards and requirements. Nonetheless, such components are subject to these terms.

No TI components are authorized for use in FDA Class III (or similar life-critical medical equipment) unless authorized officers of the parties have executed a special agreement specifically governing such use.

Only those TI components which TI has specifically designated as military grade or "enhanced plastic" are designed and intended for use in military/aerospace applications or environments. Buyer acknowledges and agrees that any military or aerospace use of TI components which have **not** been so designated is solely at the Buyer's risk, and that Buyer is solely responsible for compliance with all legal and regulatory requirements in connection with such use.

TI has specifically designated certain components which meet ISO/TS16949 requirements, mainly for automotive use. Components which have not been so designated are neither designed nor intended for automotive use; and TI will not be responsible for any failure of such components to meet such requirements.

Products

Audio	www.ti.com/audio
Amplifiers	amplifier.ti.com
Data Converters	dataconverter.ti.com
DLP® Products	www.dlp.com
DSP	dsp.ti.com
Clocks and Timers	www.ti.com/clocks
Interface	interface.ti.com
Logic	logic.ti.com
Power Mgmt	power.ti.com
Microcontrollers	microcontroller.ti.com
RFID	www.ti-rfid.com
OMAP Applications Processors	www.ti.com/omap
Wireless Connectivity	www.ti.com/wirelessconnectivity

Applications

Automotive and Transportation	www.ti.com/automotive
Communications and Telecom	www.ti.com/communications
Computers and Peripherals	www.ti.com/computers
Consumer Electronics	www.ti.com/consumer-apps
Energy and Lighting	www.ti.com/energy
Industrial	www.ti.com/industrial
Medical	www.ti.com/medical
Security	www.ti.com/security
Space, Avionics and Defense	www.ti.com/space-avionics-defense
Video and Imaging	www.ti.com/video

TI E2E Community

e2e.ti.com