



**MICROCHIP**

---

**RN52 Bluetooth® Audio  
Evaluation Kit User's Guide**

Datasheet.Cloud

---

**Note the following details of the code protection feature on Microchip devices:**

- Microchip products meet the specification contained in their particular Microchip Data Sheet.
- Microchip believes that its family of products is one of the most secure families of its kind on the market today, when used in the intended manner and under normal conditions.
- There are dishonest and possibly illegal methods used to breach the code protection feature. All of these methods, to our knowledge, require using the Microchip products in a manner outside the operating specifications contained in Microchip's Data Sheets. Most likely, the person doing so is engaged in theft of intellectual property.
- Microchip is willing to work with the customer who is concerned about the integrity of their code.
- Neither Microchip nor any other semiconductor manufacturer can guarantee the security of their code. Code protection does not mean that we are guaranteeing the product as "unbreakable."

Code protection is constantly evolving. We at Microchip are committed to continuously improving the code protection features of our products. Attempts to break Microchip's code protection feature may be a violation of the Digital Millennium Copyright Act. If such acts allow unauthorized access to your software or other copyrighted work, you may have a right to sue for relief under that Act.

---

Information contained in this publication regarding device applications and the like is provided only for your convenience and may be superseded by updates. It is your responsibility to ensure that your application meets with your specifications. MICROCHIP MAKES NO REPRESENTATIONS OR WARRANTIES OF ANY KIND WHETHER EXPRESS OR IMPLIED, WRITTEN OR ORAL, STATUTORY OR OTHERWISE, RELATED TO THE INFORMATION, INCLUDING BUT NOT LIMITED TO ITS CONDITION, QUALITY, PERFORMANCE, MERCHANTABILITY OR FITNESS FOR PURPOSE. Microchip disclaims all liability arising from this information and its use. Use of Microchip devices in life support and/or safety applications is entirely at the buyer's risk, and the buyer agrees to defend, indemnify and hold harmless Microchip from any and all damages, claims, suits, or expenses resulting from such use. No licenses are conveyed, implicitly or otherwise, under any Microchip intellectual property rights.

**Trademarks**

The Microchip name and logo, the Microchip logo, dsPIC, FlashFlex, KEELOQ, KEELOQ logo, MPLAB, PIC, PICmicro, PICSTART, PIC<sup>32</sup> logo, rPIC, SST, SST Logo, SuperFlash and UNI/O are registered trademarks of Microchip Technology Incorporated in the U.S.A. and other countries.

FilterLab, Hampshire, HI-TECH C, Linear Active Thermistor, MTP, SEEVAL and The Embedded Control Solutions Company are registered trademarks of Microchip Technology Incorporated in the U.S.A.

Silicon Storage Technology is a registered trademark of Microchip Technology Inc. in other countries.

Analog-for-the-Digital Age, Application Maestro, BodyCom, chipKIT, chipKIT logo, CodeGuard, dsPICDEM, dsPICDEM.net, dsPICworks, dsSPEAK, ECAN, ECONOMONITOR, FanSense, HI-TIDE, In-Circuit Serial Programming, ICSP, Mindi, MiWi, MPASM, MPF, MPLAB Certified logo, MPLIB, MPLINK, mTouch, Omniscient Code Generation, PICC, PICC-18, PICDEM, PICDEM.net, PICkit, PICtail, REAL ICE, rLAB, Select Mode, SQI, Serial Quad I/O, Total Endurance, TSHARC, UniWinDriver, WiperLock, ZENA and Z-Scale are trademarks of Microchip Technology Incorporated in the U.S.A. and other countries.

SQTP is a service mark of Microchip Technology Incorporated in the U.S.A.

GestIC and ULPP are registered trademarks of Microchip Technology Germany II GmbH & Co. KG, a subsidiary of Microchip Technology Inc., in other countries.

All other trademarks mentioned herein are property of their respective companies.

© 2014, Microchip Technology Incorporated, Printed in the U.S.A., All Rights Reserved.

 Printed on recycled paper.

ISBN: 978-1-63276-021-0

**QUALITY MANAGEMENT SYSTEM  
CERTIFIED BY DNV  
= ISO/TS 16949 =**

*Microchip received ISO/TS-16949:2009 certification for its worldwide headquarters, design and wafer fabrication facilities in Chandler and Tempe, Arizona; Gresham, Oregon and design centers in California and India. The Company's quality system processes and procedures are for its PIC<sup>®</sup> MCUs and dsPIC<sup>®</sup> DSCs, KEELOQ<sup>®</sup> code hopping devices, Serial EEPROMs, microperipherals, nonvolatile memory and analog products. In addition, Microchip's quality system for the design and manufacture of development systems is ISO 9001:2000 certified.*

### Object of Declaration: RN52 Bluetooth Audio Evaluation Kit

#### EU Declaration of Conformity

This declaration of conformity is issued by the manufacturer.

The development/evaluation tool is designed to be used for research and development in a laboratory environment. This development/evaluation tool is not a Finished Appliance, nor is it intended for incorporation into Finished Appliances that are made commercially available as single functional units to end users under EU EMC Directive 2004/108/EC and as supported by the European Commission's Guide for the EMC Directive 2004/108/EC (8<sup>th</sup> February 2010).

This development/evaluation tool complies with EU RoHS2 Directive 2011/65/EU.

For information regarding the exclusive, limited warranties applicable to Microchip products, please see Microchip's standard terms and conditions of sale, which are printed on our sales documentation and available at [www.microchip.com](http://www.microchip.com).

Signed for and on behalf of Microchip Technology Inc. at Chandler, Arizona, USA

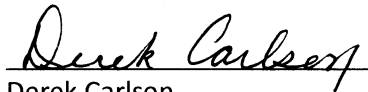

Derek Carlson  
VP Development Tools

16-July-2013

Date

NOTES:



# RN52 BLUETOOTH AUDIO EVALUATION KIT USER'S GUIDE

---

---

## Table of Contents

---

---

<b>Preface</b> .....	<b>7</b>
<b>Chapter 1. Overview</b>	
1.1 Introduction .....	13
1.2 RN52 Evaluation Kit Features .....	13
1.3 RN52 Evaluation Kit Contents and Part Details .....	14
1.4 RN-52-EK Evaluation Board .....	15
1.5 RN52 Evaluation Kit Related Information Contents .....	17
<b>Chapter 2. Getting Started</b>	
2.1 Introduction .....	19
2.2 Hardware Requirements .....	19
2.3 Power Up the Board .....	20
2.4 Using the Evaluation Kit .....	20
<b>Chapter 3. Application Demonstrations</b>	
3.1 Audio Demonstration .....	27
3.2 HSP/HFP Demonstration .....	28
<b>Appendix A. RN52 Audio Evaluation Kits Schematics</b>	
A.1 Introduction .....	29
A.2 RN52 Evaluation Kits Schematic .....	29
A.3 RN52 Evaluation Kits PCB Layout and Assemble Drawings .....	31
A.4 RN52 Evaluation Kits Bill of Materials .....	34
A.5 RN52 Evaluation Kits Physical Dimensions .....	35
<b>Worldwide Sales and Service</b> .....	<b>37</b>

# RN52 Bluetooth Audio Evaluation Kit User's Guide

---

---

NOTES:

---

---

## Preface

---

---

### NOTICE TO CUSTOMERS

All documentation becomes dated, and this manual is no exception. Microchip tools and documentation are constantly evolving to meet customer needs, so some actual dialogs and/or tool descriptions may differ from those in this document. Please refer to our web site ([www.microchip.com](http://www.microchip.com)) to obtain the latest documentation available.

Documents are identified with a “DS” number. This number is located on the bottom of each page, in front of the page number. The numbering convention for the DS number is “DSXXXXA”, where “XXXX” is the document number and “A” is the revision level of the document.

For the most up-to-date information on development tools, see the MPLAB® IDE on-line help. Select the Help menu, and then Topics to open a list of available on-line help files.

## INTRODUCTION

This chapter contains general information that will be useful to know before using the Product Name. Items discussed in this chapter include:

- [Document Layout](#)
- [Conventions Used in this Guide](#)
- [Warranty Registration](#)
- [Recommended Reading](#)
- [The Microchip Web Site](#)
- [Development Systems Customer Change Notification Service](#)
- [Customer Support](#)
- [Document Revision History](#)

## DOCUMENT LAYOUT

This user's guide describes how to use the RN52 Bluetooth Audio Evaluation Kit. The document is organized as follows:

- **Chapter 1. “Overview”** – This chapter introduces the RN52 Bluetooth Audio Evaluation Kit and provides an overview of various features.
- **Chapter 2. “Getting Started”** – This chapter describes the hardware components and setup of the RN52 Bluetooth Audio Evaluation Kit.
- **Chapter 3. “Application Demonstrations”** – This chapter describes the application demonstrations of the RN52 Bluetooth Audio Evaluation Kit.
- **Appendix A. “RN52 Audio Evaluation Kits Schematics”** – This appendix includes a schematic of the RN-52-EK Evaluation Board, and the Bill of Materials.

# RN52 Bluetooth Audio Evaluation Kit User's Guide

## CONVENTIONS USED IN THIS GUIDE

This manual uses the following documentation conventions:

### DOCUMENTATION CONVENTIONS

Description	Represents	Examples
<b>Arial font:</b>		
Italic characters	Referenced books	<i>MPLAB® IDE User's Guide</i>
	Emphasized text	...is the <i>only</i> compiler...
Initial caps	A window	the Output window
	A dialog	the Settings dialog
	A menu selection	select Enable Programmer
Quotes	A field name in a window or dialog	"Save project before build"
Underlined, italic text with right angle bracket	A menu path	<u><i>File&gt;Save</i></u>
Bold characters	A dialog button	Click <b>OK</b>
	A tab	Click the <b>Power</b> tab
N'Rnnnn	A number in verilog format, where N is the total number of digits, R is the radix and n is a digit	4'b0010, 2'hF1
Text in angle brackets < >	A key on the keyboard	Press <Enter>, <F1>
<b>Courier New font:</b>		
Plain Courier New	Sample source code	#define START
	Filenames	autoexec.bat
	File paths	c:\mcc18\h
	Keywords	_asm, _endasm, static
	Command-line options	-Opa+, -Opa-
	Bit values	0, 1
	Constants	0xFF, 'A'
Italic Courier New	A variable argument	<i>file.o</i> , where <i>file</i> can be any valid filename
Square brackets [ ]	Optional arguments	mcc18 [options] <i>file</i> [options]
Curly brackets and pipe character: {   }	Choice of mutually exclusive arguments; an OR selection	errorlevel {0 1}
Ellipses...	Replaces repeated text	var_name [, var_name...]
	Represents code supplied by user	void main (void) { ... }



## WARRANTY REGISTRATION

Please complete the enclosed Warranty Registration Card and mail it promptly. Sending in the Warranty Registration Card entitles users to receive new product updates. Interim software releases are available at the Microchip web site.

## RECOMMENDED READING

This user's guide describes how to use the RN-52-EK Evaluation Board. Other useful documents are listed below. The following Microchip documents are available and recommended as supplemental reference resources:

RN52 Bluetooth Audio Module Data Sheet (DS70005120)

PICDEM™ PIC18 Explorer Demonstration Board User's Guide (DS51721)

Explorer 16 Development Board User's Guide (DS51589)

Bluetooth Audio Module Command Reference User's Guide (DS50002154)

For more information, refer to the following sources:

- RN52/RN52N Class 2 Bluetooth Module Data Sheet
- Bluetooth Command Reference and Advanced Information User's Guide

# RN52 Bluetooth Audio Evaluation Kit User's Guide

---

## THE MICROCHIP WEB SITE

Microchip provides online support via our web site at <http://www.microchip.com>. This web site is used as a means to make files and information easily available to customers. Accessible by using your favorite Internet browser, the web site contains the following information:

- **Product Support** – Data sheets and errata, application notes and sample programs, design resources, user's guides and hardware support documents, latest software releases and archived software
- **General Technical Support** – Frequently Asked Questions (FAQs), technical support requests, online discussion groups, Microchip consultant program member listing
- **Business of Microchip** – Product selector and ordering guides, latest Microchip press releases, listing of seminars and events, listings of Microchip sales offices, distributors and factory representatives

## DEVELOPMENT SYSTEMS CUSTOMER CHANGE NOTIFICATION SERVICE

Microchip's customer notification service helps keep customers current on Microchip products. Subscribers will receive e-mail notification whenever there are changes, updates, revisions or errata related to a specified product family or development tool of interest.

To register, access the Microchip web site at <http://www.microchip.com>, click on Customer Change Notification and follow the registration instructions.

The Development Systems product group categories are:

- **Compilers** – The latest information on Microchip C compilers and other language tools. These include the MPLAB<sup>®</sup> C compiler; MPASM<sup>™</sup> and MPLAB 16-bit assemblers; MPLINK<sup>™</sup> and MPLAB 16-bit object linkers; and MPLIB<sup>™</sup> and MPLAB 16-bit object librarians.
- **Emulators** – The latest information on the Microchip MPLAB REAL ICE<sup>™</sup> in-circuit emulator.
- **In-Circuit Debuggers** – The latest information on the Microchip in-circuit debugger, MPLAB ICD 3.
- **MPLAB IDE** – The latest information on Microchip MPLAB IDE, the Windows<sup>®</sup> Integrated Development Environment for development systems tools. This list is focused on the MPLAB IDE, MPLAB SIM simulator, MPLAB IDE Project Manager and general editing and debugging features.
- **Programmers** – The latest information on Microchip programmers. These include the MPLAB PM3 device programmer and the PICKit<sup>™</sup> 3 development programmers.

## CUSTOMER SUPPORT

Users of Microchip products can receive assistance through several channels:

- Distributor or Representative
- Local Sales Office
- Field Application Engineer (FAE)
- Technical Support

Customers should contact their distributor, representative or Field Application Engineer (FAE) for support. Local sales offices are also available to help customers. A listing of sales offices and locations is included in the back of this document.

Technical support is available through the web site at: <http://support.microchip.com>

## DOCUMENT REVISION HISTORY

### Revision A (March 2014)

This is the initial released version of this document.

# RN52 Bluetooth Audio Evaluation Kit User's Guide

---

NOTES:

---

---

## Chapter 1. Overview

---

---

### 1.1 INTRODUCTION

This user's guide describes the hardware and software setup for the RN52 Bluetooth® Audio Evaluation Kit. This kit contains the hardware needed to evaluate the RN52 Bluetooth audio module. The RN52 module is mounted to an evaluation board that demonstrates the module's key features. The evaluation board contains:

- Dual-channel audio output and input
- Easy access to GPIO pins
- Built-in amplifier for stereo audio output
- 6 push buttons to control audio playback
- Status LEDs
- Connections for the programmer and UART interfaces

The RN52 supports the following Bluetooth profiles:

- A2DP stereo audio (Sink mode with support for Sub-Band Coding (SBC), Advanced Audio Coding (AAC) and aptX® codecs)
- AVRCP media player remote control
- HFP/HSP for accepting a phone call with 3-way calling and caller-ID support
- Support for Clear Voice Capture® (cVc) voice enhancement through HFP/HSP
- SPP (allows the module to receive serial data over the UART)
- iAP profile discovery for iOS devices

The evaluation kit can be used to configure and program the Bluetooth module using the command interface, create connections, and transfer data. The command interface is made up of simple ASCII commands. For more details, refer to the “*RN52 Bluetooth Audio Module Data Sheet*”, “*Bluetooth Audio Module Command Reference User's Guide*”, and “*Bluetooth Command Reference and Advanced Information User's Guide*”.

For data sheet and other details related to RN52 module, refer to the Microchip web site at <http://www.microchip.com>.

This chapter discusses the following topics:

- [RN52 Evaluation Kit Features](#)
- [RN52 Evaluation Kit Contents and Part Details](#)
- [RN-52-EK Evaluation Board](#)
- [RN52 Evaluation Kit Related Information Contents](#)

### 1.2 RN52 EVALUATION KIT FEATURES

#### 1.2.1 RN52 Evaluation Board Features

The RN52 Evaluation Board has the following features:

- Fully qualified Bluetooth version 3.0 module, fully compatible with Bluetooth version 2.1 + Enhanced Data Rate (EDR), 1.2, and 1.1
- Backwards-compatibility with Bluetooth version 2.0, 1.2, and 1.1
- Software configurable through commands over UART console interface

# RN52 Bluetooth Audio Evaluation Kit User's Guide

- Dedicated GPIO pins enable MCUs to access control and status functions efficiently
- Embedded RN-52 module with postage-stamp size form factor of 13.5 x 26.0 x 2.7 mm
- Embedded Bluetooth stack profiles: A2DP, AVRCP, HFP/HSP, and SPP
- Dual-channel, differential audio input and output for highest quality audio
- Supports iAP profile to discover iOS devices and apps (requires a special firmware build)
- Integrated amplifier for driving 16  $\Omega$  speakers
- UART (SPP) data connection interfaces
- External audio CODECs supported via S/PDIF and I2S interface
- Castellated SMT pads for easy and reliable PCB mounting
- Environmentally friendly, RoHS compliant
- Certifications: FCC, IC, and CE
- Bluetooth SIG certified

## 1.3 RN52 EVALUATION KIT CONTENTS AND PART DETAILS

The evaluation kit includes the hardware required to connect the evaluation board to the host computer. See [Table 1-1](#). To evaluate the module on the evaluation board, the user needs a computer with a USB port running the Microsoft Windows or Mac OS-X operating system.

**Note:** Prior to the evaluation, install the FTDI driver for the USB cable. If the drivers are not automatically installed, download and install the FTDI drivers from the Microchip web site at <http://ww1.microchip.com/downloads/en/DeviceDoc/FTDI-Drivers.zip> for FTDI Chipset Drivers.

Depending on the development kit ordered, the package contains the following:

- **RN-52-EK Board** - Contains the Bluetooth module and connectors. Supports Standard application firmware (A2DP/AVRCP/SPP) master and slave
- **Mini-USB cable** - Links user's computer to the evaluation board
- **Stereo mini-speakers** - Rechargeable battery-powered speakers

[Table 1-1](#) lists the part number of RN-52-EK Evaluation Kit.

**TABLE 1-1: RN52 EVALUATION KIT PART DETAILS**

Description	Part Number
RN52 Evaluation board	RN-52-EK
Mini-USB cable	—
Duo Rechargeable Mini-Speaker Set (includes Universal 3.5mm Audio Plug and USB cable)	—
Hands Free Clip on Mini Lapel Microphone	—

Figure 1-1 illustrates the RN-52-EK evaluation kit contents.

**FIGURE 1-1: EVALUATION KIT CONTENTS**

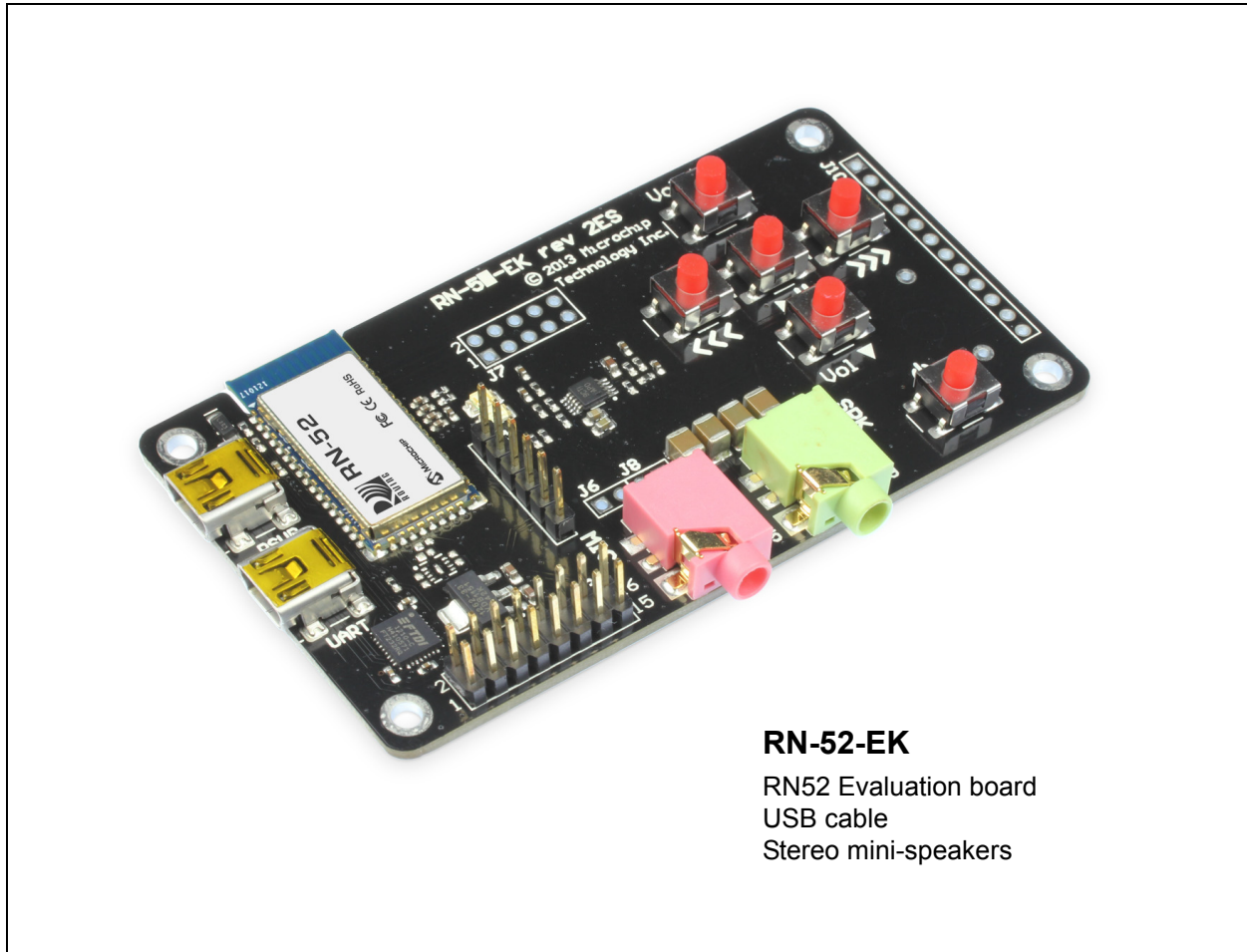

## 1.4 RN-52-EK EVALUATION BOARD

RN52 Audio Evaluation Board contains the following components as shown in [Figure 1-2](#) which describes the evaluation board's interfaces and connectors. [Table 1-2](#) describes the various components of the evaluation board.

# RN52 Bluetooth Audio Evaluation Kit User's Guide

FIGURE 1-2: RN-52-EK EVALUATION BOARD

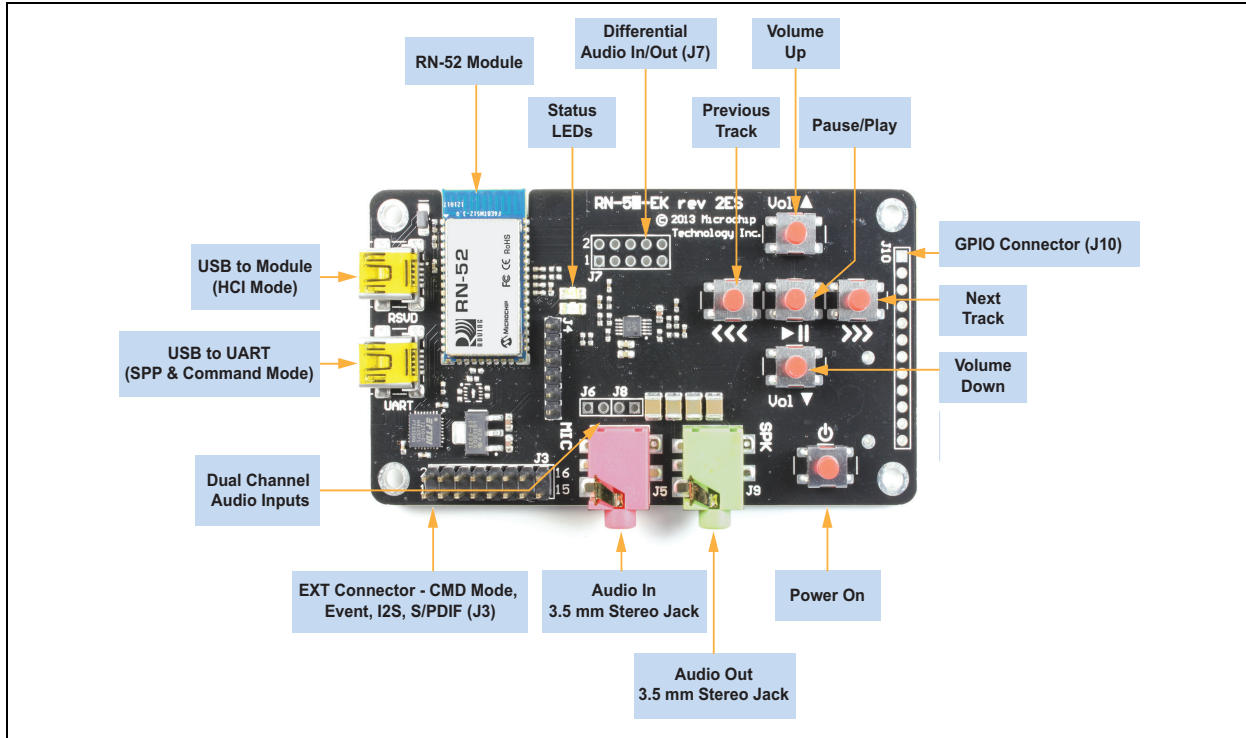

**EXT Connector - CMD Mode, Event, I2S, S/PDIF (J3)**

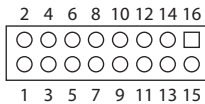

Pin	Description
1	UART_TX
2	VBUS
3	UART_RX
4	AIO0
5	GPIO9
6	GND
7	GND
8	I2S_IN
9	GND
10	I2S_OUT
11	GND
12	I2S_SYNC
13	GND
14	I2S_CLK
15	GND
16	3.3 V

**Differential Audio In/Out (J7)**

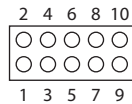

Pin	Description
1	SPKR_R-
2	MIC_L+
3	SPKR_L-
4	MIC_R+
5	SPKR_R+
6	MIC_L-
7	SPKR_L+
8	MIC_R-
9	GND
10	MIC_BIAS

**MIC Right (J6)**



Pin	Description
1	MIC_R
2	GND

**GPIO Connector (J10)**

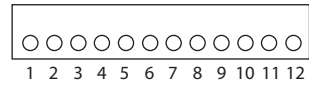

Pin	Description
1	GND
2	GPIO2
3	GPIO4
4	BTN_VOLUP
5	BTN_NEXT
6	BTN_PLAY
7	BTN_PREVIOUS
8	BTN_VOLDOWN
9	GPIO7
10	GPIO6
11	PWREN
12	3.3 V

**MIC Left (J8)**



Pin	Description
1	MIC_L
2	GND



**TABLE 1-2: RN52 AUDIO EVALUATION KIT HARDWARE**

Hardware Component	Description
RN-52	Bluetooth® v3.0 module
USB to UART (UART)	USB to UART serial bridge for command and SPP modes
USB to Module (RSVD)	USB interface to RN-52 module for DFU, HCI, and other modes
Power On	Switch to turn on the RN-52 module. Power to the RN-52-EK is provided through USB to UART serial bridge.
Audio Out	Audio 3.5 mm jack for audio playback
Audio In	Audio 3.5 mm jack for microphone input
Status LEDs	Red and Blue LEDs show the pairing/connection status
Play/Pause Button	Button to play or pause the audio playback
Previous Track Button	Button to skip track backwards
Next Track Button	Button to skip track forwards
Volume Up Button	Button to increase volume
Volume Down Button	Button to decrease volume
J3 Connection Header	Provides access to GPIOs, UART, and I2S. Controls switch to command mode over GPIO9.
J7 Connection Header	Provides access to analogue audio interface
J10 Connection Header	Provides access to GPIOs used for player control buttons, power enable pin and other GPIOs
J6 Connection Header	Provides access to microphone-right input
J8 Connection Header	Provides access to microphone-left input

## 1.5 RN52 EVALUATION KIT RELATED INFORMATION CONTENTS

For more details on software and other documentation, refer to the Microchip web site at <http://www.microchip.com/RN-52-EK>.

**Note:** All the factory-shipped RN modules are available with firmware version and profile details. For more information on RN module links, refer to “*Bluetooth Audio Module Command Reference User’s Guide and Bluetooth Command Reference and Advanced Information User’s Guide*” from the Microchip web site <http://www.microchip.com>.

# RN52 Bluetooth Audio Evaluation Kit User's Guide

---

NOTES:

---

---

## Chapter 2. Getting Started

---

---

### 2.1 INTRODUCTION

This chapter describes how the RN52 Audio Evaluation Kit board works using the ASCII command set. Certain hardware and software/utilities are essential to support the evaluation/development of demo applications. This chapter discusses the following topics:

- Hardware Requirements
- Software/Utility Requirements
- Module Configuration

### 2.2 HARDWARE REQUIREMENTS

Along with an USB cable RN-52-EK boards are required for evaluation hardware setup and to run the firmware/demo applications.

#### 2.2.1 Hardware Setup

To setup the evaluation hardware, perform the following steps:

1. Connect the mini-USB cable to your computer's USB port and to the evaluation board's UART (USB-UART bridge) connector. This connection provides power to the board, and provides a virtual serial data port connection to the command console and in SPP mode.
2. Prior to the evaluation, install the FTDI driver for the USB cable.

**Note:** If the drivers are not automatically installed, download and install the FTDI drivers from the Microchip web site at <http://ww1.microchip.com/downloads/en/DeviceDoc/FTDI-Drivers.zip> for FTDI Chipset Drivers.

3. Note down the assigned computer COM port to which the RN-52-EK is attached through the cable connected.
4. Connect the portable mini-speaker 3.5 mm to the stereo audio out connector (J9).

Figure 2-1 shows the completed hardware setup for the evaluation board.

# RN52 Bluetooth Audio Evaluation Kit User's Guide

FIGURE 2-1: CONNECTED HARDWARE SETUP

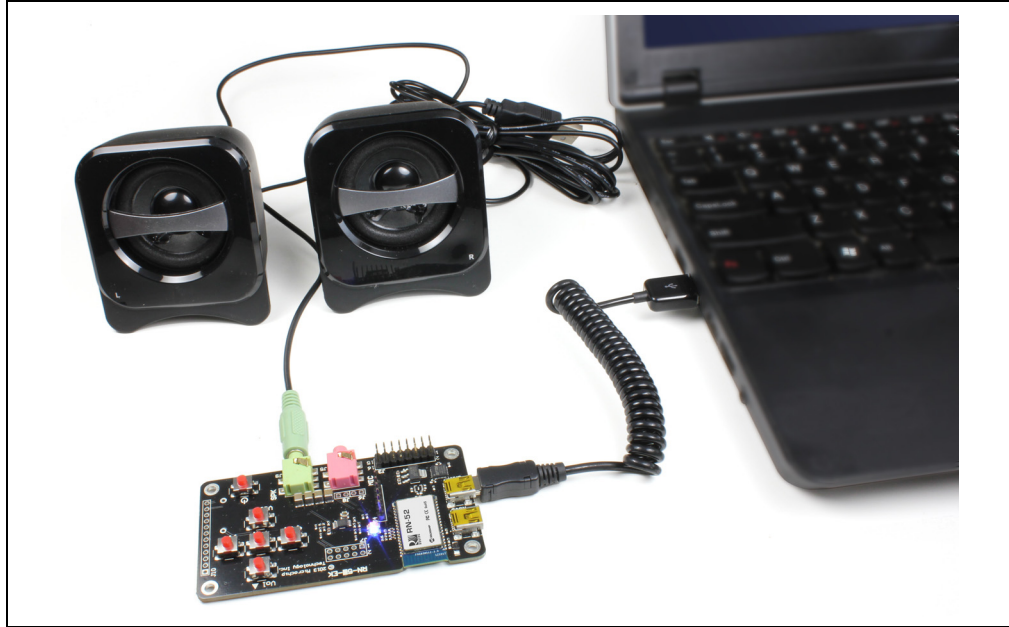

## 2.3 POWER UP THE BOARD

To power-up the board, connect the board to a power source via USB, and then press and hold the evaluation board's power-on button until the speakers issue a two-tone alert. The RN52 evaluation board's status LEDs give user a visual confirmation that the board is powered up and operating. See [Table 2-1](#).

TABLE 2-1: RN52 AUDIO EVALUATION BOARD STATUS LEDS

LED	Status	Description
Blue and red	Flashing	The RN52 module is discoverable
Blue only	Flashing	The module is connectable
Red only	Flashing	The module is connected

## 2.4 USING THE EVALUATION KIT

This section of the user's guide assumes that users have a basic working knowledge of Bluetooth operation and communications. To configure the Bluetooth devices, a Bluetooth-enabled PC (either built-in or using a USB Bluetooth dongle) is required. Only one device can be configured at a time. Once programmed and configured, device settings are saved (independent of power down) until they are explicitly changed or the factory defaults are restored.

The RN52 uses simple ASCII commands sent over UART interface to: *set* commands to configure the Bluetooth module and *get* commands to echo the current configuration. Configuration settings modified with the *set* command do not take effect until the module has been rebooted, even though the *get* command may show otherwise.

**Note:** For detailed information on the ASCII commands used to configure the Bluetooth module, refer to the “*Bluetooth Command Reference and Advanced Information User's Guide*”.

## 2.4.1 Command Mode vs. Data Mode

The Bluetooth device operates in two modes: Data mode (default) and Command mode. While in Data mode, the module is essentially a data pipe. When the module receives data from SPP Bluetooth connections, it strips the Bluetooth headers and trailers and passes the user data to the UART Receive (RX) line. When data is written to the UART Transmit (TX) line, the module constructs the Bluetooth packet and sends it out over to the Bluetooth SPP. Thus, the entire process of sending/receiving data to the host is transparent to the end microprocessor. Figure 2-2 illustrates the Bluetooth communication pipe.

FIGURE 2-2: DATA & COMMAND MODES

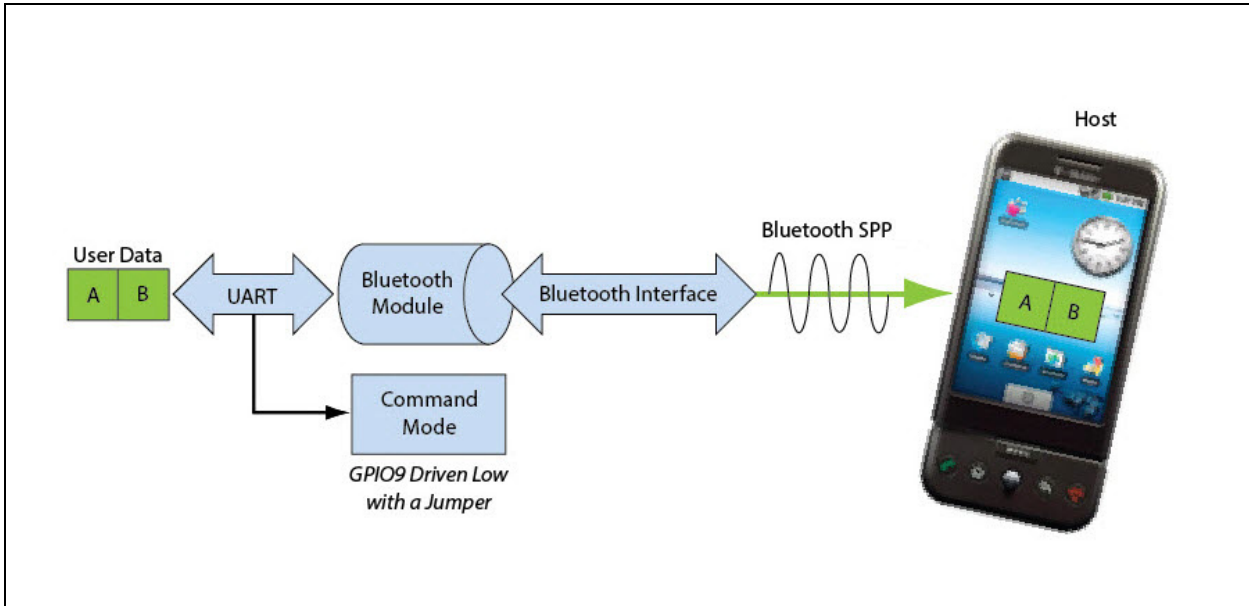

The default configuration for the Bluetooth device is:

- Bluetooth Slave mode
- Keyboard Default Authentication mode (no pin code required)
- Serial port 115,200 Kbps baud rate, 8 bits, no parity, one stop bit
- Serial port flow control enabled
- Low-Power mode off

The device can be configured by putting it into Command mode and sending ASCII commands over a serial port. Once the configuration parameters are changed, the parameters persist until it is changed. Otherwise, a Factory Reset is performed.

**Note:** User can only configure the Bluetooth audio module locally using host computer's serial port. The module *cannot* be configured remotely over the Bluetooth link.

Terminal emulator application/program on PC is required to complete the setup.

**Note:** Depending on the operating system, the users can opt to use either the TeraTerm (Windows OS) or CoolTerm (Mac OS-X) terminal emulator programs.

# RN52 Bluetooth Audio Evaluation Kit User's Guide

## 2.4.2 Configure the Module Using the UART

Setup the RN-52-EK hardware as described in **Section 2.2.1 “Hardware Setup”**. With the Bluetooth device connected and powered on, run a terminal emulator and open the COM port to which the RN-52-EK link cable is connected. Configure the virtual COM port connected to the RN-52-EK USB interface with the default settings (115,200 Kbps baud, no parity, 8 bits, 1 stop bit). The terminal emulator's communication settings should be the default serial port settings.

Command mode can be switched through the UART interface via the USB connector at any time when the device does NOT have a Bluetooth connection, as well as under certain conditions. If the device is in configuration mode and a connection occurs, the device exits configuration mode and data passes back and forth from the remote device.

**Note:** Local configuration can be used at any time when the device does NOT have a Bluetooth connection, as well as under certain conditions. If the device is in Configuration mode and a connection occurs, the device exits Configuration mode and data passes back and forth from the remote device.

## 2.4.3 Enter Command Mode

The RN52 module enters Command mode when GPIO09 goes low. The RN52 module leaves command mode and enters data mode when GPIO09 goes high. With the RN-52-EK evaluation board, use a jumper to switch between command and data modes.

Launch a terminal emulator and specify the adapter's default settings. [Figure 2-3](#) shows the serial port settings dialog box for TeraTerm (open this dialog box by choosing *Setup > Serial Port*).

**FIGURE 2-3: SERIAL PORT SETTINGS IN TERATERM**

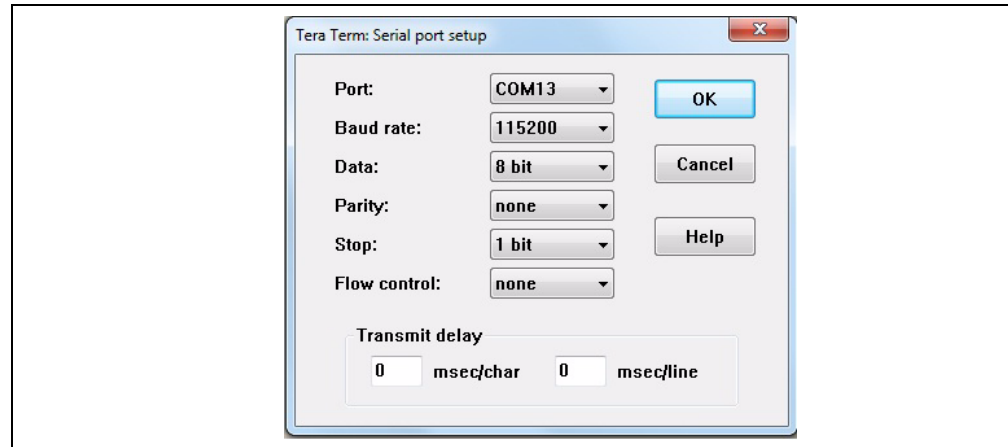

To place the module on the RN-52-EK evaluation board into Command mode, connect a jumper to header pins 5 (GPIO9) and 6 (GND) on J3. Refer to [Figure 2-4](#) and its Connector-Pin details. After entering Command mode, the module sends `CMD` to the UART as acknowledgement.

**FIGURE 2-4: GPIO9 LOCATION**

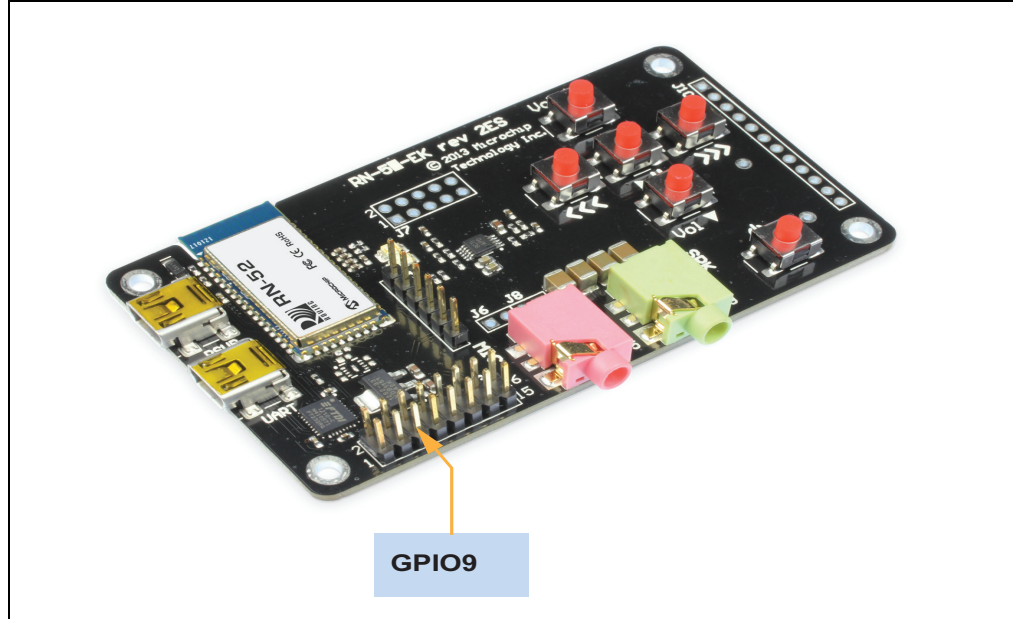

Type the following commands into the Tera Term console:

```
+ // Turn on local echo
v // Display the firmware version
d // Display the current settings
q // Show the connection status
```

To switch into Data mode, remove the jumper from header pins 5 (GPIO9) and 6 (GND) on J3. When leaving Command mode, the module sends `END` to the UART. [Figure 2-5](#) shows the Tera Term console after performing these actions.

**FIGURE 2-5: COMMAND MODE ACTIONS IN A SERIAL TERMINAL EMULATOR**

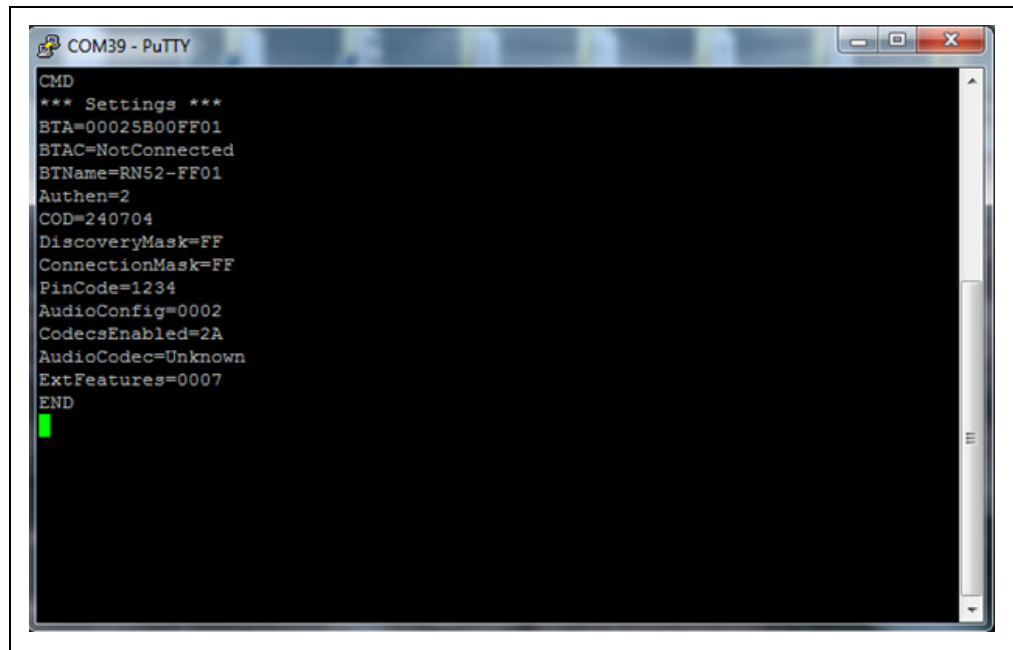

# RN52 Bluetooth Audio Evaluation Kit User's Guide

---

## 2.4.4 Making a Bluetooth Connection

By default, the Bluetooth adapter acts as a slave and the PC is the master. Connect to the Bluetooth adapter using the computer's Bluetooth device manager, which varies depending on the operating system. Regardless of the operating system, the process is the same: Discovery, Pairing, and Connecting.

### 2.4.4.1 DISCOVERY

When the RN-52-EK is turned on, the Blue and Red LED should blink and the adapter should be discoverable. Open the host PC's Bluetooth device manager and choose to add a new device. The Bluetooth device manager's icon is located at the bottom right corner on the host's computer screen in the taskbar for Windows; and at the upper right corner for Mac OS-X. The Bluetooth device manager displays a list of discoverable Bluetooth devices. The board displays as **RN52-XXXX**, where XXXX is the last 4-digits of the module's MAC address.

### 2.4.4.2 PAIRING

The module supports the following pairing methods:

- Legacy Pairing using PIN code
- Secure Simple Pairing (SSP)
  - Just Works
  - Numeric Comparison using Yes/No Keyboard IO

The RN-52 module can be configured through command console to use either of the above pairing methods.

To pair with the module, double click its name in the Bluetooth device scan list. The default authentication mode is Just Works which requires no user interaction. The link key is generated, stored and a connection gets established. For subsequent connections, the stored link keys are compared and the connection is established. The module's firmware automatically stores up to 8 pairings from remote hosts in a first in, first out fashion.

If the remote Bluetooth device does not require authentication, a connection can occur without the pairing process. However, the Bluetooth specification requires that if either device involved in the pairing process requires authentication, the other device must participate to ensure a secure link. Microchip modules default to Just Works mode and do not require authentication.

In numeric comparison using yes/no keyboard IO mode, the user is shown a 6-digit number on both the module console and the pairing device display. The user has to verify that the numbers match or do not match on both devices by entering yes or no. A command is provided to enter yes or no on the module command console.

In legacy pairing mode, the pairing device requests a 4-digit fixed PIN for authentication. In this case, use the module's default PIN code, 1234, as the pass key. After entering the PIN code, the Bluetooth devices are compared. If a match is found, a link key is generated and stored. Usually, but not always, the remote device stores the link key. For subsequent connections, the devices compare link keys. If correct, there is no need to re-enter the PIN code. The PIN code can be set as desired using command console.

To remove the stored link key on the remote device, you typically "unpair" or remove the device from the Bluetooth manager. The pairing information can be reset by executing the reset Paired Device List (PDL) on the command console. You can change the PIN code to remove the link key on the Bluetooth adapter, forcing a new pin code exchange to occur upon subsequent connection attempts.



Figure 2-6 shows examples of Bluetooth devices discovered list and pair/connect interfaces.

**Note:** For detailed information on the pairing mode commands, refer to the “*Bluetooth Command Reference and Advanced Information User’s Guide*”.

**FIGURE 2-6: PAIRING/CONNECTING WITH THE BLUETOOTH® ADAPTER**

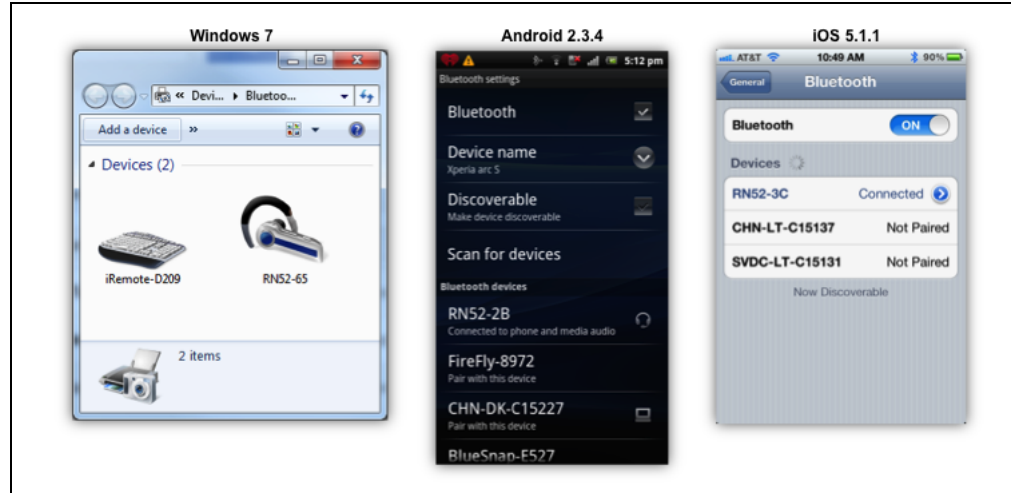

### 2.4.4.3 CONNECTING

If the pairing with the device is successful, the module can connect to the device. Click connect using the pair/connect interface to establish a connection.

Once connected, the module enables Advanced Audio Distribution Profile (A2DP) for audio playback and Audio Video Remote Control Profile (AVRCP) for player control.

Additionally, a Serial Port Profile (SPP) link can be established by opening the virtual COM port available on the RN52 module from a PC over its Bluetooth device.

When connecting to a PC using SPP, after the Bluetooth device manager completes pairing/connecting, it issues a message that the Bluetooth device is installed on COM port X where the specific COM port is unique to the user’s computer. After connecting successfully, the data can be transmitted and received on the Bluetooth COM port link in Data mode.

In some cases, the Bluetooth device manager creates two COM ports. In this situation, use the incoming port to wait for the module to initiate a connection. Open the outgoing port to establish a connection to the module.

# RN52 Bluetooth Audio Evaluation Kit User's Guide

---

NOTES:

---

---

**Chapter 3. Application Demonstrations**

---

---

**3.1 AUDIO DEMONSTRATION**

In this demonstration, user can play an audio stream on the RN-52-EK using a computer or smartphone. The evaluation board broadcasts the audio through the mini-speakers. The following are the steps to perform the demonstration:

1. Connect the RN-52-EK to a host device (PC or smartphone) that has an audio source.
2. Connect a pair of headphones or self-powered speakers to the RN-52-EK board's audio out connector (J9).
3. Open the audio source on the host device. Microchip recommends using a media player (e.g., Microsoft Media Player, iTunes, and Android).
4. Start the audio stream on the media player.

When the RN-52-EK is connected to an audio source compatible with Bluetooth AVRCP, the audio control buttons are used to:

- Control the volume output
- Go to the previous track
- Go to the next track
- Start/stop playing the current track

Figure 3-1 shows the location of the audio control buttons.

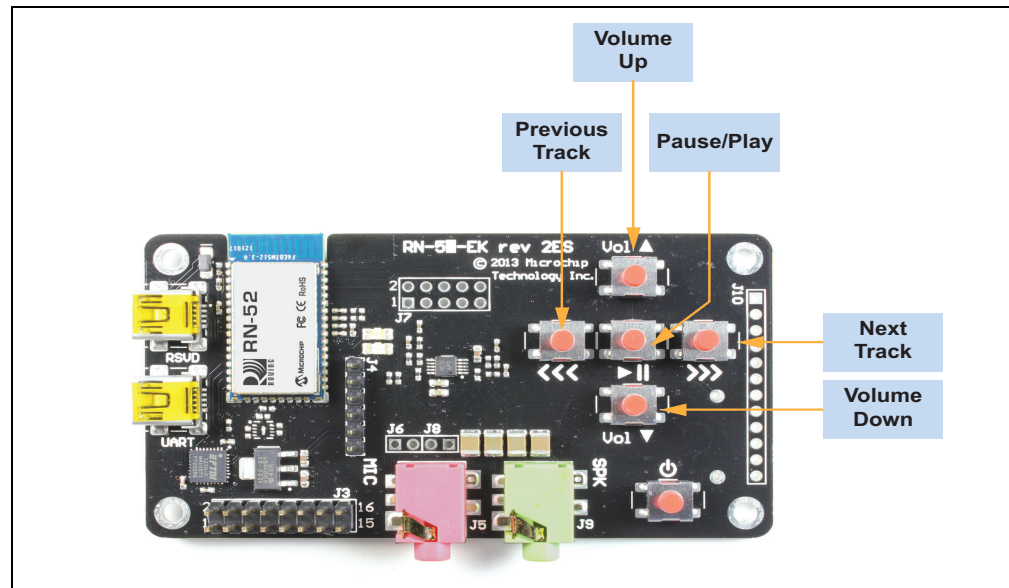
**FIGURE 3-1: AUDIO CONTROL BUTTONS**

The RN-52 module supports SBC codec, AAC and aptX optional codecs for audio playback using A2DP profile. The optional codec is negotiated during connection if supported on the connecting device. If optional codecs are not supported, the RN-52

# RN52 Bluetooth Audio Evaluation Kit User's Guide

---

defaults to the mandatory SBC codec. The optional codecs can be enabled or disabled using the Command mode. For more information on the audio codecs, refer to the “RN52 Bluetooth Audio Module Data Sheet”.

## 3.2 HSP/HFP DEMONSTRATION

In this demonstration, the RN52EK user can explore the hands-free profile setting to receive an incoming voice call from a paired smartphone. This demonstration requires a microphone. It would be good to use a PC headset/microphone (with two-plugs). The following are the steps to perform the demonstration:

1. Connect the RN-52-EK via a USB cable to a PC that has a terminal emulator.
2. Connect the headset/microphone to the RN-52-EK board's audio out connector (J9) and audio in (J5) respectively.
3. From the phone's Bluetooth control panel, pair and connect the RN-52-EK to a smartphone that supports the A2DP and HFP/HSP Bluetooth profiles.
4. On host PC, identify the virtual serial port connection to the RN-52-EK UART USB port.
5. In a terminal emulator, open this port with the settings: 115,200 Kbps baud rate, 8 bits, no parity, one stop bit.
6. Connect a jumper to header pins 5 and 6 (GPIO9) on J3. Refer back to [Figure 2-4](#). The terminal emulator displays `CMD`, indicating that the RN52 module is in command mode and the user can connect to it via the UART.
7. Try the following commands:
  - D—Display settings
  - H—Help
  - Q—Connection status (a non-zero value indicates the device is connected)From CMD mode in the terminal emulator, enter the “Q” command to retrieve connection status. The second byte should indicate state “03” (connected).
8. From another phone, initiate a call to the smartphone that is paired with the RN-52-EK. The A2DP stream pauses and the ringtone plays on the headset/microphone.
9. The music pauses on the smartphone and the ringtone plays.
10. From CMD mode in the terminal emulator, enter the “Q” command to retrieve connection status. The second byte should indicate state “05” (incoming call).
11. From CMD mode in the terminal emulator, enter the “C” command to accept the incoming call.
12. From CMD mode in the terminal emulator, enter the “Q” command to retrieve connection status. The second byte should indicate state “06” (active call).
13. End the call from smartphone. The call can also be dropped using the “E” command from CMD mode.
14. Issue “Q” command in CMD mode, the second byte must state “0C” to indicate A2DP music stream is playing.
15. Follow the instructions on **Section 3.1 “Audio Demonstration”** and initiate an A2DP audio stream.

The RN-52 module supports cVc voice enhancement. It includes echo cancellation, noise suppression, and optional automatic gain control algorithms. The cVc voice enhancement can be enabled or disabled using the Command mode. For more information on cVc, refer to the “RN52 Bluetooth Audio Module Data Sheet”.

---

---

**Appendix A. RN52 Audio Evaluation Kits Schematics**

---

---

**A.1 INTRODUCTION**

This appendix provides the RN52 Evaluation Boards schematic, PCB layout and Bill of Materials (BOM).

- [RN52 Evaluation Kits Schematic](#)
- [RN52 Evaluation Kits PCB Layout and Assemble Drawings](#)
- [RN52 Evaluation Kits Bill of Materials](#)
- [RN52 Evaluation Kits Physical Dimensions](#)

**A.2 RN52 EVALUATION KITS SCHEMATIC**

[Figure A-1](#) shows the RN-52-EK schematic.

# RN52 Bluetooth Audio Evaluation Kit User's Guide

FIGURE A-1: RN52 EVALUATION BOARD SCHEMATIC

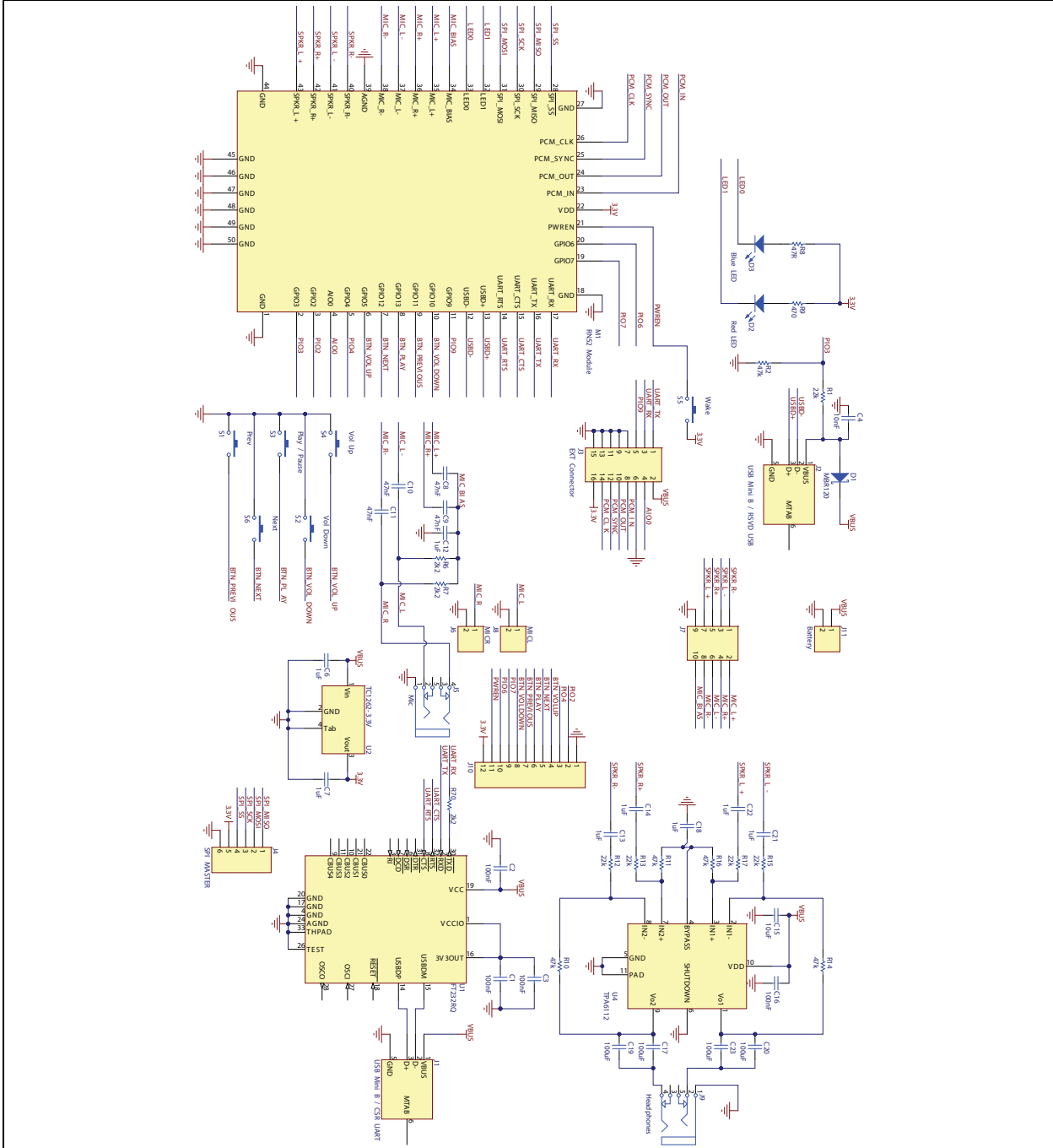

# RN52 Audio Evaluation Kits Schematics

## A.3 RN52 EVALUATION KITS PCB LAYOUT AND ASSEMBLE DRAWINGS

The RN52 Evaluation Board is a 2-layer, FR4, 0.062 inch, plated through a hole PCB construction. Figure A-2 through Figure A-7 show the PCB constructions and Assembly Drawings.

FIGURE A-2: RN52 EVALUATION BOARD TOP SILKSCREEN

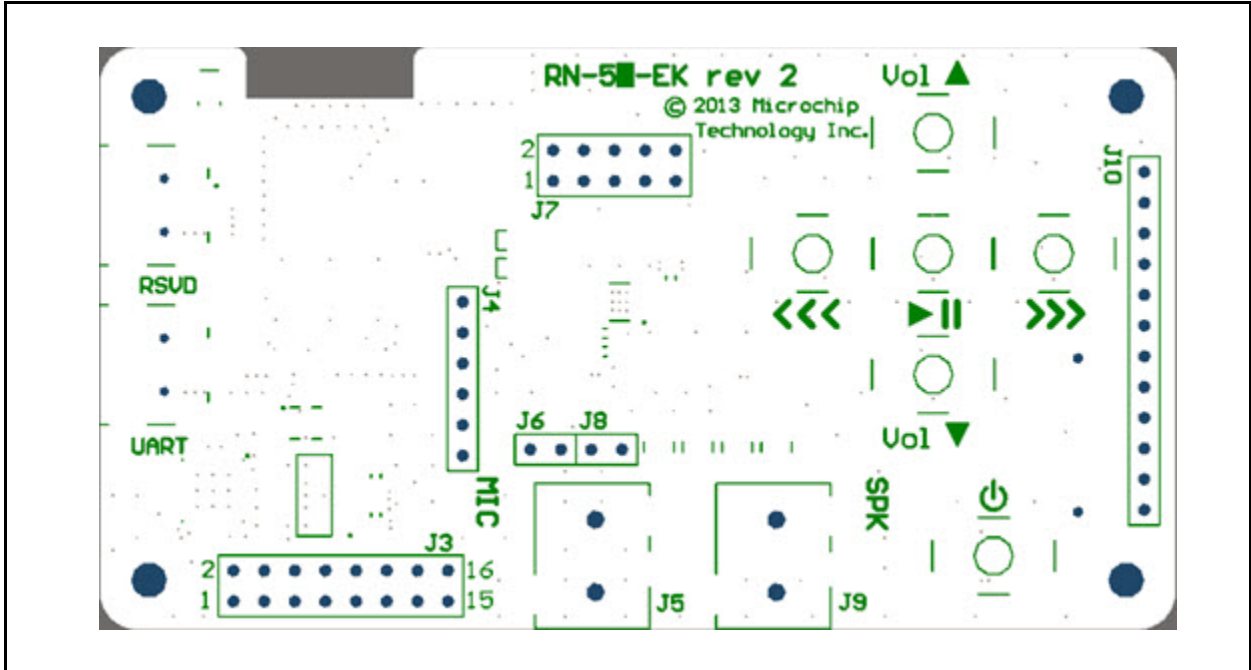
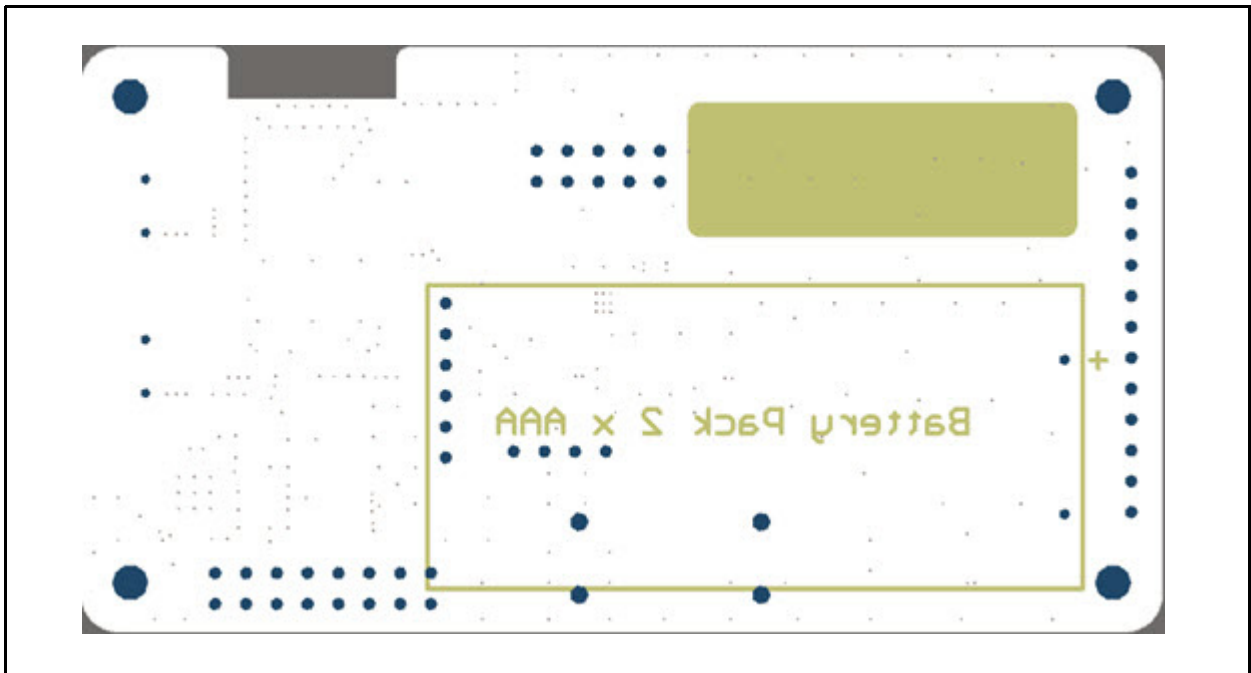

FIGURE A-3: RN52 EVALUATION BOARD BOTTOM SILKSCREEN



# RN52 Bluetooth Audio Evaluation Kit User's Guide

FIGURE A-4: RN52 EVALUATION BOARD TOP COPPER

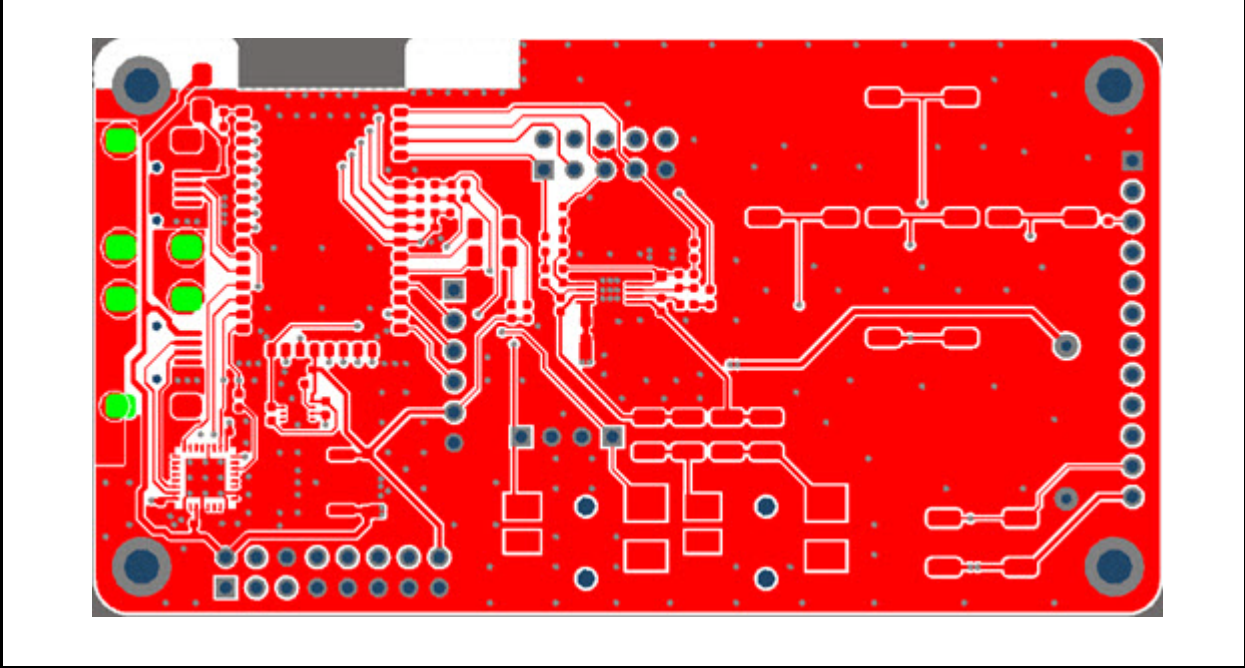
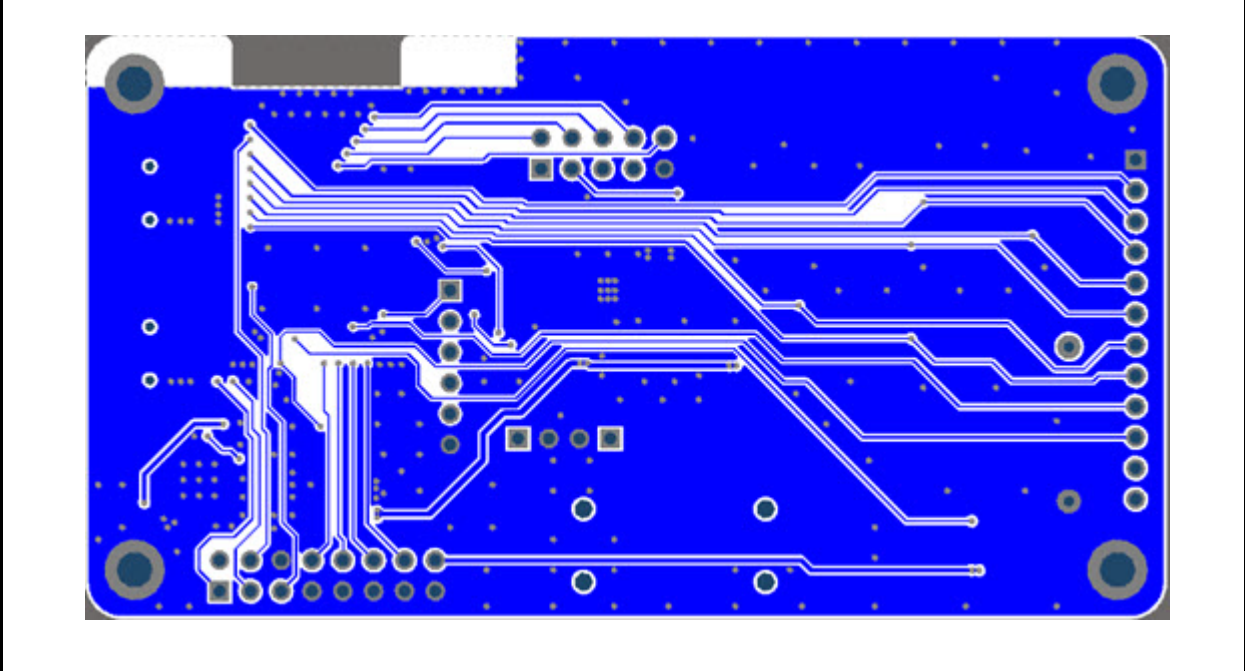

FIGURE A-5: RN52 EVALUATION BOARD BOTTOM COPPER





# RN52 Audio Evaluation Kits Schematics

FIGURE A-6: RN52 EVALUATION BOARD TOP ASSEMBLY

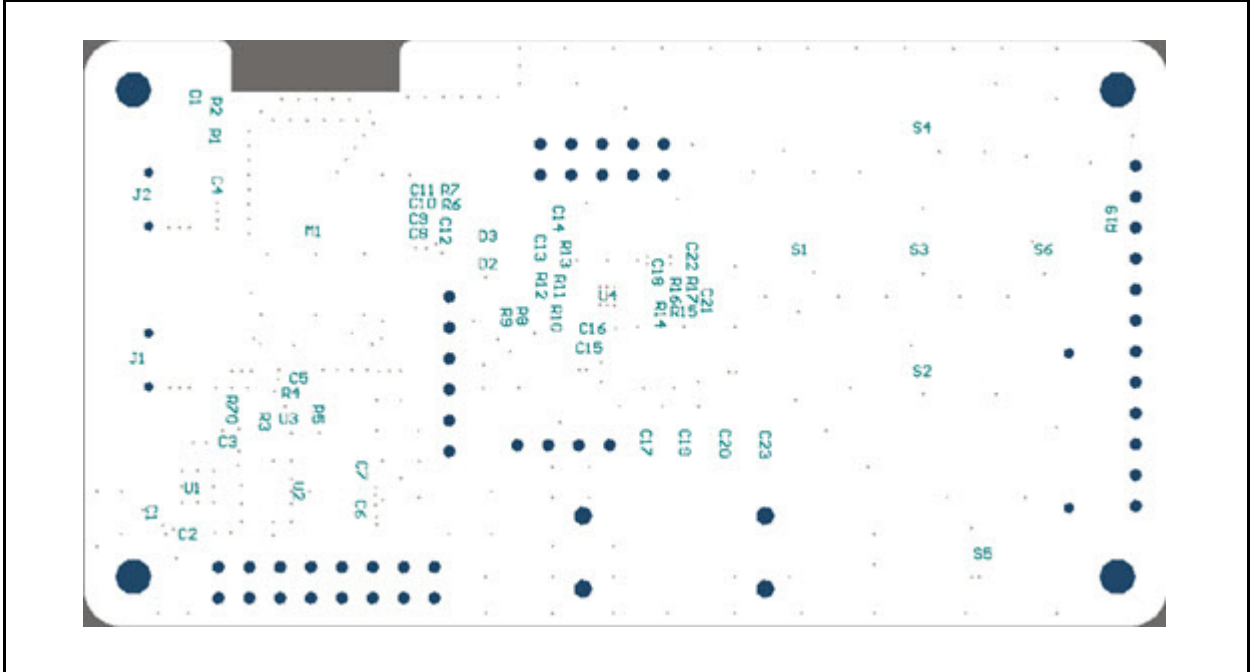
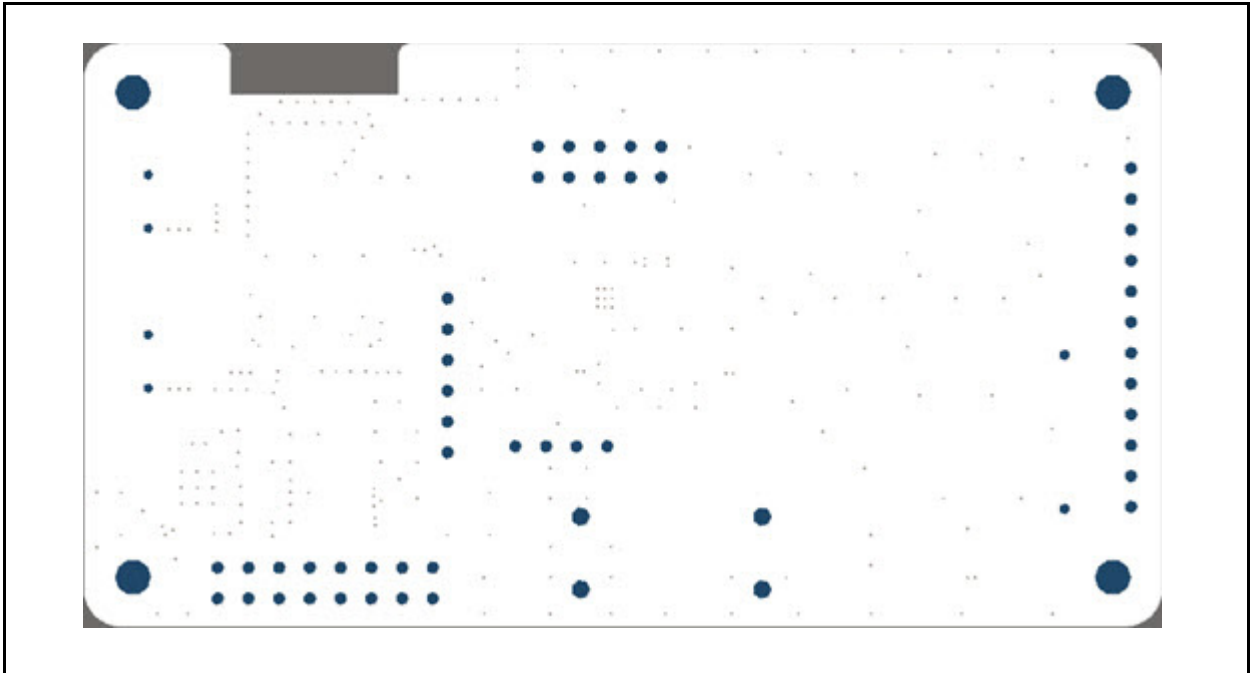

FIGURE A-7: RN52 EVALUATION BOARD BOTTOM ASSEMBLY



# RN52 Bluetooth Audio Evaluation Kit User's Guide

## A.4 RN52 EVALUATION KITS BILL OF MATERIALS

TABLE A-1: RN-52-EK BOARD BILL OF MATERIALS

Reference	Value	Description	Vendor	Vendor P/N
C1, C2, C3	100 nF	Capacitor, Ceramic, -20%, 80%, 16V, Y5V, 0402	Yageo	CC0402ZRY5V7BB104
C4	10 nF	Capacitor, Ceramic, 10%, 50V, X7R, 0402	Yageo	CC0402KRX7R9BB103
C6, C7, C18	1 $\mu$ F	Capacitor, Ceramic, -20% / 80%, 16V, Y5V, 0603	Yageo	CC0603ZRY5V7BB105
C8, C9, C10, C11	47 nF	Capacitor, Ceramic, 10%, 16V, X7R, 0402	Taiyo Yuden	EMK105B7473KV-F
C12, C13, C14, C21, C22	1 $\mu$ F	Capacitor, Ceramic, 10%, 16V, X5R, 0402	TDK Corporation	C1005X5R1C105K
C15	10 $\mu$ F	Capacitor, Ceramic, 20%, 10V, X5R, 0603	TDK Corporation	C1608X5R1A106M
C16	100 nF	Capacitor, Ceramic, -20% / 80%, 16V, Y5V, 0603	Yageo	CC0603ZRY5V7BB104
C17, C19, C20, C23	100 $\mu$ F	Capacitor, Ceramic, -20%, +80%, 6.3V, Y5V, 1206	Taiyo Yuden	JMK325F107ZM-T
D1	MBR120	Schottky Diode, 1 A, 20 V, SOD-123F	ON Semiconductor	MBR120ESFT1G
D2	Red LED	Clear, Red LED, 10 mA, 1.8 V, 638 nm, 130 degrees, 1206	Lite-On Inc	LTST-C150CKT
D3	Blue LED	Clear, Blue LED, 20 mA, 3.3 V, 470 nm, 130 degrees, 1206	Lite-On Inc	LTST-C150TBKT
J1, J2	USB Mini B / CSR UART, USB Mini B / CSR USB	Connector USB RCPT MINI B 5PS R/A SMD	JAE	DX2R005HN2E700
J3	–	Generic 0.1" Pitch 2x8 Male Pin Header	–	–
J4	–	Generic 0.1" Pitch 1x6 Male Pin Header	–	–
J5	Audio Jack, Pink	Connector, jack stereo, 5POS 3.5 mm SMD	CUI, Inc.	SJ1-3515-SMT-PI
J9	Audio Jack, Green	Connector, jack stereo, 5POS 3.5 mm SMD	CUI, Inc.	SJ1-3515-SMT-GR
M1	–	RN-52 Module	Microchip	RN-52
R1, R12, R13, R15, R17	22 k $\Omega$	Res, 5%, 0.1 W, 0402	Panasonic - ECG	ERJ-2GEJ223X
R2, R10, R11, R14, R16	47 k $\Omega$	Res, 5%, 0.1 W, 0402	Panasonic - ECG	ERJ-2GEJ473X
R6, R7, R70	2k2	Res, 5%, 0.1 W, 0402	Panasonic - ECG	ERJ-2GEJ222X
R8	47R	Res, 5%, 0.1 W, 0402	Panasonic - ECG	ERJ-2GEJ470X
R9	470	Res, 5%, 0.1 W, 0402	Panasonic - ECG	ERJ-2GEJ471X
S1, S2, S3, S4, S5, S6	Push button	Tactile and Jog Switches 6x6 260gf Red SMT	Mountain Switch	101-TS6923T2605-EV
U1	FT232RQ	IC USB FS Serial UART 32-QFN	FTDI	FT232RQ-REEL
U2	TC1262-3.3V	Linear Voltage Regulator	Microchip	TC1262-3.3VDBTR
U4	TPA6112	IC Amp Audio Power .15 W AB 10MSOP	Texas Instruments	TPA6112A2DGQR

# RN52 Audio Evaluation Kits Schematics

## A.5 RN52 EVALUATION KITS PHYSICAL DIMENSIONS

Figure A-8 shows the physical dimensions of the RN52 Evaluation Board.

FIGURE A-8: RN-52 PHYSICAL DIMENSIONS

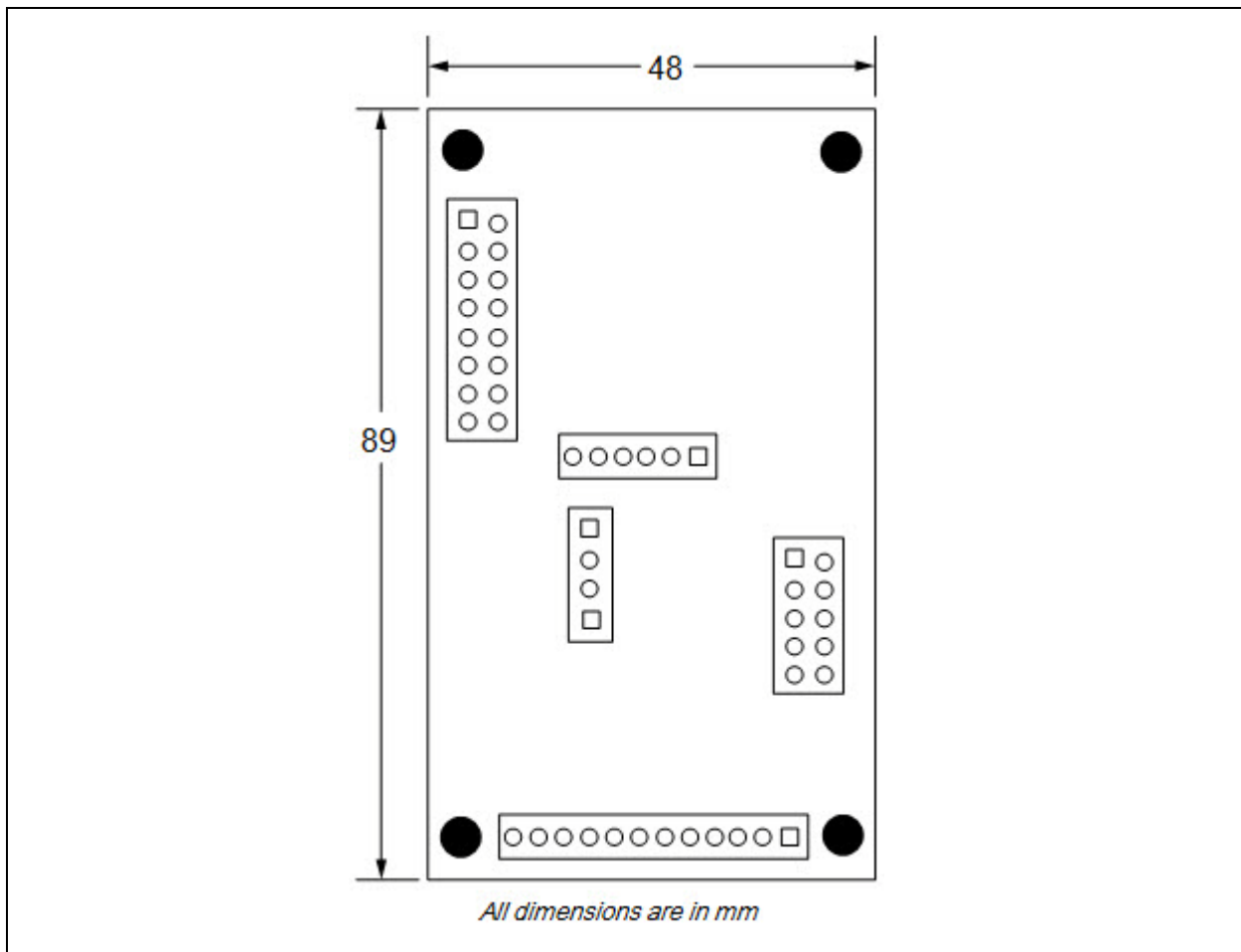

# RN52 Bluetooth Audio Evaluation Kit User's Guide

---

NOTES:



# MICROCHIP

## Worldwide Sales and Service

### AMERICAS

**Corporate Office**  
2355 West Chandler Blvd.  
Chandler, AZ 85224-6199  
Tel: 480-792-7200  
Fax: 480-792-7277  
Technical Support:  
<http://www.microchip.com/support>  
Web Address:  
[www.microchip.com](http://www.microchip.com)

**Atlanta**  
Duluth, GA  
Tel: 678-957-9614  
Fax: 678-957-1455

**Austin, TX**  
Tel: 512-257-3370

**Boston**  
Westborough, MA  
Tel: 774-760-0087  
Fax: 774-760-0088

**Chicago**  
Itasca, IL  
Tel: 630-285-0071  
Fax: 630-285-0075

**Cleveland**  
Independence, OH  
Tel: 216-447-0464  
Fax: 216-447-0643

**Dallas**  
Addison, TX  
Tel: 972-818-7423  
Fax: 972-818-2924

**Detroit**  
Novi, MI  
Tel: 248-848-4000

**Houston, TX**  
Tel: 281-894-5983

**Indianapolis**  
Noblesville, IN  
Tel: 317-773-8323  
Fax: 317-773-5453

**Los Angeles**  
Mission Viejo, CA  
Tel: 949-462-9523  
Fax: 949-462-9608

**New York, NY**  
Tel: 631-435-6000

**San Jose, CA**  
Tel: 408-735-9110

**Canada - Toronto**  
Tel: 905-673-0699  
Fax: 905-673-6509

### ASIA/PACIFIC

**Asia Pacific Office**  
Suites 3707-14, 37th Floor  
Tower 6, The Gateway  
Harbour City, Kowloon  
Hong Kong  
Tel: 852-2401-1200  
Fax: 852-2401-3431

**Australia - Sydney**  
Tel: 61-2-9868-6733  
Fax: 61-2-9868-6755

**China - Beijing**  
Tel: 86-10-8569-7000  
Fax: 86-10-8528-2104

**China - Chengdu**  
Tel: 86-28-8665-5511  
Fax: 86-28-8665-7889

**China - Chongqing**  
Tel: 86-23-8980-9588  
Fax: 86-23-8980-9500

**China - Hangzhou**  
Tel: 86-571-8792-8115  
Fax: 86-571-8792-8116

**China - Hong Kong SAR**  
Tel: 852-2943-5100  
Fax: 852-2401-3431

**China - Nanjing**  
Tel: 86-25-8473-2460  
Fax: 86-25-8473-2470

**China - Qingdao**  
Tel: 86-532-8502-7355  
Fax: 86-532-8502-7205

**China - Shanghai**  
Tel: 86-21-5407-5533  
Fax: 86-21-5407-5066

**China - Shenyang**  
Tel: 86-24-2334-2829  
Fax: 86-24-2334-2393

**China - Shenzhen**  
Tel: 86-755-8864-2200  
Fax: 86-755-8203-1760

**China - Wuhan**  
Tel: 86-27-5980-5300  
Fax: 86-27-5980-5118

**China - Xian**  
Tel: 86-29-8833-7252  
Fax: 86-29-8833-7256

**China - Xiamen**  
Tel: 86-592-2388138  
Fax: 86-592-2388130

**China - Zhuhai**  
Tel: 86-756-3210040  
Fax: 86-756-3210049

### ASIA/PACIFIC

**India - Bangalore**  
Tel: 91-80-3090-4444  
Fax: 91-80-3090-4123

**India - New Delhi**  
Tel: 91-11-4160-8631  
Fax: 91-11-4160-8632

**India - Pune**  
Tel: 91-20-3019-1500

**Japan - Osaka**  
Tel: 81-6-6152-7160  
Fax: 81-6-6152-9310

**Japan - Tokyo**  
Tel: 81-3-6880-3770  
Fax: 81-3-6880-3771

**Korea - Daegu**  
Tel: 82-53-744-4301  
Fax: 82-53-744-4302

**Korea - Seoul**  
Tel: 82-2-554-7200  
Fax: 82-2-558-5932 or  
82-2-558-5934

**Malaysia - Kuala Lumpur**  
Tel: 60-3-6201-9857  
Fax: 60-3-6201-9859

**Malaysia - Penang**  
Tel: 60-4-227-8870  
Fax: 60-4-227-4068

**Philippines - Manila**  
Tel: 63-2-634-9065  
Fax: 63-2-634-9069

**Singapore**  
Tel: 65-6334-8870  
Fax: 65-6334-8850

**Taiwan - Hsin Chu**  
Tel: 886-3-5778-366  
Fax: 886-3-5770-955

**Taiwan - Kaohsiung**  
Tel: 886-7-213-7830

**Taiwan - Taipei**  
Tel: 886-2-2508-8600  
Fax: 886-2-2508-0102

**Thailand - Bangkok**  
Tel: 66-2-694-1351  
Fax: 66-2-694-1350

### EUROPE

**Austria - Wels**  
Tel: 43-7242-2244-39  
Fax: 43-7242-2244-393

**Denmark - Copenhagen**  
Tel: 45-4450-2828  
Fax: 45-4485-2829

**France - Paris**  
Tel: 33-1-69-53-63-20  
Fax: 33-1-69-30-90-79

**Germany - Dusseldorf**  
Tel: 49-2129-3766400

**Germany - Munich**  
Tel: 49-89-627-144-0  
Fax: 49-89-627-144-44

**Germany - Pforzheim**  
Tel: 49-7231-424750

**Italy - Milan**  
Tel: 39-0331-742611  
Fax: 39-0331-466781

**Italy - Venice**  
Tel: 39-049-7625286

**Netherlands - Drunen**  
Tel: 31-416-690399  
Fax: 31-416-690340

**Poland - Warsaw**  
Tel: 48-22-3325737

**Spain - Madrid**  
Tel: 34-91-708-08-90  
Fax: 34-91-708-08-91

**Sweden - Stockholm**  
Tel: 46-8-5090-4654

**UK - Wokingham**  
Tel: 44-118-921-5800  
Fax: 44-118-921-5820

03/13/14