



MAX4475–MAX4478/MAX4488/MAX4489 SOT23, Low-Noise, Low-Distortion, Wide-Band, Rail-to-Rail Op Amps

General Description

The MAX4475–MAX4478/MAX4488/MAX4489 wide-band, low-noise, low-distortion operational amplifiers offer rail-to-rail outputs and single-supply operation down to 2.7V. They draw 2.2mA of quiescent supply current per amplifier while featuring ultra-low distortion (0.0002% THD+N), as well as low input voltage-noise density (4.5nV/√Hz) and low input current-noise density (0.5fA/√Hz). These features make the devices an ideal choice for applications that require low distortion and/or low noise.

For power conservation, the MAX4475/MAX4488 offer a low-power shutdown mode that reduces supply current to 0.01μA and places the amplifiers' outputs into a high-impedance state. These amplifiers have outputs which swing rail-to-rail and their input common-mode voltage range includes ground. The MAX4475–MAX4478 are unity-gain stable with a gain-bandwidth product of 10MHz. The MAX4488/4489 are internally compensated for gains of +5V/V or greater with a gain-bandwidth product of 42MHz. The single MAX4475/MAX4476/MAX4488 are available in space-saving, 6-pin SOT23 and TDFN packages.

Applications

- ADC Buffers
- DAC Output Amplifiers
- Low-Noise Microphone/Preamplifiers
- Digital Scales
- Strain Gauges/Sensor Amplifiers
- Medical Instrumentation

μMAX is a registered trademark of Maxim Integrated Products, Inc.

Typical Operating Characteristic

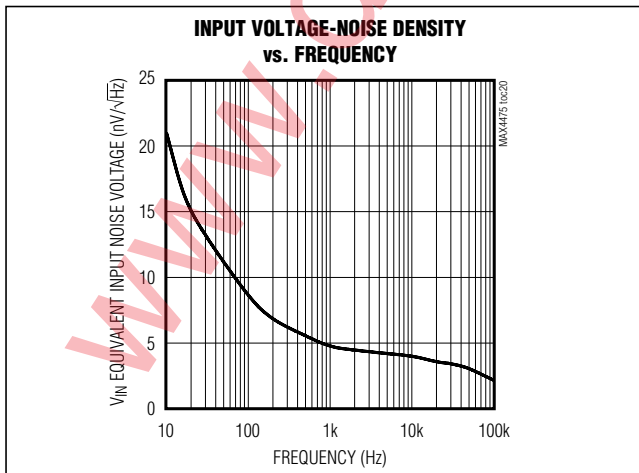

Features

- ◆ **Low Input Voltage-Noise Density:** 4.5nV/√Hz
- ◆ **Low Input Current-Noise Density:** 0.5fA/√Hz
- ◆ **Low Distortion:** 0.0002% THD+N (1kΩ load)
- ◆ **Single-Supply Operation** from +2.7V to +5.5V
- ◆ **Input Common-Mode Voltage Range** Includes Ground
- ◆ **Rail-to-Rail Output Swings** with a 1kΩ Load
- ◆ **10MHz GBW Product, Unity-Gain Stable** (MAX4475–MAX4478)
- ◆ **42MHz GBW Product, Stable** with $A_v \geq +5V/V$ (MAX4488/MAX4489)
- ◆ **Excellent DC Characteristics**
 - $V_{OS} = 70\mu V$
 - $I_{BIAS} = 1pA$
 - Large-Signal Voltage Gain** = 120dB
- ◆ **Low-Power Shutdown Mode:**
 - Reduces Supply Current** to 0.01μA
 - Places Output** in High-Impedance State
- ◆ **Available in Space-Saving SOT23, TDFN, μMAX®, and TSSOP Packages**

Ordering Information

PART	TEMP RANGE	PIN-PACKAGE	TOP MARK
MAX4475AUT+T	-40°C to +125°C	6 SOT23	AAZV
MAX4475AUA+	-40°C to +125°C	8 μMAX	—
MAX4475ASA+	-40°C to +125°C	8 SO	—
MAX4475ATT+T	-40°C to +125°C	6 TDFN-EP*	+ADD
MAX4475AUT/V+T	-40°C to +125°C	6 SOT23	+ACQQ

+Denotes a lead(Pb)-free/RoHS-compliant package.

*EP = Exposed pad (connect to V_{SS}).

/V denotes an automotive qualified part.

T = Tape and reel.

Ordering Information continued at end of data sheet.

Pin Configurations and Typical Operating Circuit appear at end of data sheet.

Selector Guide

PART	GAIN BW (MHz)	STABLE GAIN (V/V)	NO. OF AMPS	SHDN
MAX4475	10	1	1	Yes
MAX4476	10	1	1	—
MAX4477	10	1	2	—
MAX4478	10	1	4	—
MAX4488	42	5	1	Yes
MAX4489	42	5	2	—

For pricing, delivery, and ordering information, please contact Maxim Direct at 1-888-629-4642, or visit Maxim's website at www.maximintegrated.com.

MAX4475-MAX4478/MAX4488/MAX4489

SOT23, Low-Noise, Low-Distortion, Wide-Band, Rail-to-Rail Op Amps

ABSOLUTE MAXIMUM RATINGS

Power-Supply Voltage (V_{DD} to V_{SS}).....	-0.3V to +6.0V	8-Pin SO (derate 5.88mW/°C above +70°C).....	471mW
Analog Input Voltage (IN_+ , IN_-)....($V_{SS} - 0.3V$) to ($V_{DD} + 0.3V$)		14-Pin SO (derate 8.33mW/°C above +70°C).....	667mW
\overline{SHDN} Input Voltage.....($V_{SS} - 0.3V$) to +6.0V		14-Pin TSSOP (derate 9.1mW/°C above +70°C)	727mW
Output Short-Circuit Duration to Either Supply	Continuous	Operating Temperature Range	-40°C to +125°C
Continuous Input Current (IN_+ , IN_-)	$\pm 10mA$	Junction Temperature	+150°C
Continuous Power Dissipation ($T_A = +70^\circ C$)		Storage Temperature Range	-65°C to +150°C
6-Pin SOT23 (derate 9.1mW/°C above +70°C).....	727mW	Lead Temperature (soldering, 10s)	+300°C
6-Pin TDFN (derate 18.2mW/°C above 70°C).....	1454mW	Soldering Temperature (reflow)	+260°C
8-Pin μ MAX (derate 4.5mW/°C above +70°C).....	362mW		

Stresses beyond those listed under "Absolute Maximum Ratings" may cause permanent damage to the device. These are stress ratings only, and functional operation of the device at these or any other conditions beyond those indicated in the operational sections of the specifications is not implied. Exposure to absolute maximum rating conditions for extended periods may affect device reliability.

DC ELECTRICAL CHARACTERISTICS

($V_{DD} = +5V$, $V_{SS} = 0V$, $V_{CM} = 0V$, $V_{OUT} = V_{DD}/2$, R_L tied to $V_{DD}/2$, $\overline{SHDN} = V_{DD}$, $T_A = -40^\circ C$ to $+125^\circ C$, unless otherwise noted. Typical values are at $T_A = +25^\circ C$.) (Notes 1, 2)

PARAMETER	SYMBOL	CONDITIONS		MIN	TYP	MAX	UNITS
Supply Voltage Range	V_{DD}	(Note 3)		2.7		5.5	V
Quiescent Supply Current Per Amplifier	I_D	Normal mode	$V_{DD} = 3V$		2.2		mA
			$V_{DD} = 5V$		2.5	4.4	
		Shutdown mode ($\overline{SHDN} = V_{SS}$) (Note 2)			0.01	1.0	μA
Input Offset Voltage	V_{OS}	$T_A = +25^\circ C$			± 70	± 350	μV
		$T_A = -40^\circ C$ to $+125^\circ C$				± 750	
Input Offset Voltage Tempco	TC_{VOS}				± 0.3	± 6	$\mu V/^\circ C$
Input Bias Current	I_B	(Note 4)			± 1	± 150	pA
Input Offset Current	I_{OS}	(Note 4)			± 1	± 150	pA
Differential Input Resistance	R_{IN}				1000		Ω
Input Common-Mode Voltage Range	V_{CM}	Guaranteed by CMRR Test	$T_A = +25^\circ C$	-0.2		$V_{DD} - 1.6$	V
			$T_A = -40^\circ C$ to $+125^\circ C$	-0.1		$V_{DD} - 1.7$	
Common-Mode Rejection Ratio	CMRR	$(V_{SS} - 0.2V) \leq V_{CM} \leq (V_{DD} - 1.6V)$	$T_A = +25^\circ C$	90	115		dB
			$T_A = -40^\circ C$ to $+125^\circ C$	90			
Power-Supply Rejection Ratio	PSRR	$V_{DD} = 2.7$ to $5.5V$		90	120		dB
Large-Signal Voltage Gain	A_{VOL}	$R_L = 10k\Omega$ to $V_{DD}/2$; $V_{OUT} = 100mV$ to $(V_{DD} - 125mV)$		90	120		dB
		$R_L = 1k\Omega$ to $V_{DD}/2$; $V_{OUT} = 200mV$ to $(V_{DD} - 250mV)$		85	110		
		$R_L = 500\Omega$ to $V_{DD}/2$; $V_{OUT} = 350mV$ to $(V_{DD} - 500mV)$		85	110		

MAX4475-MAX4478/MAX4488/MAX4489

SOT23, Low-Noise, Low-Distortion, Wide-Band, Rail-to-Rail Op Amps

DC ELECTRICAL CHARACTERISTICS (continued)

($V_{DD} = +5V$, $V_{SS} = 0V$, $V_{CM} = 0V$, $V_{OUT} = V_{DD}/2$, R_L tied to $V_{DD}/2$, $\overline{SHDN} = V_{DD}$, $T_A = -40^\circ C$ to $+125^\circ C$, unless otherwise noted. Typical values are at $T_A = +25^\circ C$.) (Notes 1, 2)

PARAMETER	SYMBOL	CONDITIONS	MIN	TYP	MAX	UNITS
Output Voltage Swing	V_{OUT}	$ V_{IN+} - V_{IN-} \geq 10mV$, $R_L = 10k\Omega$ to $V_{DD}/2$	$V_{DD} - V_{OH}$	10	45	mV
			$V_{OL} - V_{SS}$	10	40	
		$ V_{IN+} - V_{IN-} \geq 10mV$, $R_L = 1k\Omega$ to $V_{DD}/2$	$V_{DD} - V_{OH}$	80	200	
			$V_{OL} - V_{SS}$	50	150	
		$ V_{IN+} - V_{IN-} \geq 10mV$, $R_L = 500\Omega$ to $V_{DD}/2$	$V_{DD} - V_{OH}$	100	300	
			$V_{OL} - V_{SS}$	80	250	
Output Short-Circuit Current	I_{SC}		48			mA
Output Leakage Current	I_{LEAK}	Shutdown mode ($\overline{SHDN} = V_{SS}$), $V_{OUT} = V_{SS}$ to V_{DD}		± 0.001	± 1.0	μA
\overline{SHDN} Logic Low	V_{IL}				$0.3 \times V_{DD}$	V
\overline{SHDN} Logic High	V_{IH}		$0.7 \times V_{DD}$			V
\overline{SHDN} Input Current		$\overline{SHDN} = V_{SS}$ to V_{DD}		0.01	1	μA
Input Capacitance	C_{IN}			10		pF

AC ELECTRICAL CHARACTERISTICS

($V_{DD} = +5V$, $V_{SS} = 0V$, $V_{CM} = 0V$, $V_{OUT} = V_{DD}/2$, R_L tied to $V_{DD}/2$, $\overline{SHDN} = V_{DD}$, $T_A = +25^\circ C$.)

PARAMETER	SYMBOL	CONDITIONS	MIN	TYP	MAX	UNITS
Gain-Bandwidth Product	GBWP	MAX4475-MAX4478	$A_V = +1V/V$	10		MHz
		MAX4488/MAX4489	$A_V = +5V/V$	42		
Slew Rate	SR	MAX4475-MAX4478	$A_V = +1V/V$	3		V/ μs
		MAX4488/MAX4489	$A_V = +5V/V$	10		
Full-Power Bandwidth (Note 5)		MAX4475-MAX4478	$A_V = +1V/V$	0.4		MHz
		MAX4488/MAX4489	$A_V = +5V/V$	1.25		
Peak-to-Peak Input Noise Voltage	$e_{n(P-P)}$	$f = 0.1Hz$ to $10Hz$		260		nV _{P-P}
Input Voltage-Noise Density	e_n	$f = 10Hz$		21		nV/ \sqrt{Hz}
		$f = 1kHz$		4.5		
		$f = 30kHz$		3.5		
Input Current-Noise Density	i_n	$f = 1kHz$		0.5		fA/ \sqrt{Hz}
Total Harmonic Distortion Plus Noise (Note 6)	THD + N	$V_{OUT} = 2V_{P-P}$, $A_V = +1V/V$ (MAX4475-MAX4478), $R_L = 10k\Omega$ to GND	$f = 1kHz$	0.0002		%
			$f = 20kHz$	0.0007		
		$V_{OUT} = 2V_{P-P}$, $A_V = +1V/V$ (MAX4475-MAX4478), $R_L = 1k\Omega$ to GND	$f = 1kHz$	0.0002		
			$f = 20kHz$	0.001		
		$V_{OUT} = 2V_{P-P}$, $A_V = +5V/V$ (MAX4488/MAX4489), $R_L = 10k\Omega$ to GND	$f = 1kHz$	0.0004		
			$f = 20kHz$	0.0006		

MAX4475-MAX4478/MAX4488/MAX4489

SOT23, Low-Noise, Low-Distortion, Wide-Band, Rail-to-Rail Op Amps

AC ELECTRICAL CHARACTERISTICS (continued)

($V_{DD} = +5V$, $V_{SS} = 0V$, $V_{CM} = 0V$, $V_{OUT} = V_{DD}/2$, R_L tied to $V_{DD}/2$, $\overline{SHDN} = V_{DD}$, $T_A = +25^\circ C$.)

PARAMETER	SYMBOL	CONDITIONS	MIN	TYP	MAX	UNITS
Total Harmonic Distortion Plus Noise (Note 6)	THD + N	$V_{OUT} = 2V_{P-P}$, $A_V = +5V/V$ (MAX4488/MAX4489), $R_L = 1k\Omega$ to GND	$f = 1kHz$		0.0005	%
			$f = 20kHz$		0.008	
Capacitive-Load Stability		No sustained oscillations		200		pF
Gain Margin	GM			12		dB
Phase Margin	ΦM	MAX4475-MAX4478, $A_V = +1V/V$		70		degrees
		MAX4488/MAX4489, $A_V = +5V/V$		80		
Settling Time		To 0.01%, $V_{OUT} = 2V$ step		2		μs
Delay Time to Shutdown	t_{SH}			1.5		μs
Enable Delay Time from Shutdown	t_{EN}	$V_{OUT} = 2.5V$, V_{OUT} settles to 0.1%		10		μs
Power-Up Delay Time		$V_{DD} = 0$ to 5V step, V_{OUT} stable to 0.1%		13		μs

Note 1: All devices are 100% tested at $T_A = +25^\circ C$. Limits over temperature are guaranteed by design.

Note 2: \overline{SHDN} is available on the MAX4475/MAX4488 only.

Note 3: Guaranteed by the PSRR test.

Note 4: Guaranteed by design.

Note 5: Full-power bandwidth for unity-gain stable devices (MAX4475-MAX4478) is measured in a closed-loop gain of +2V/V to accommodate the input voltage range, $V_{OUT} = 4V_{P-P}$.

Note 6: Lowpass-filter bandwidth is 22kHz for $f = 1kHz$ and 80kHz for $f = 20kHz$. Noise floor of test equipment = $10nV/\sqrt{Hz}$.

Typical Operating Characteristics

($V_{DD} = +5V$, $V_{SS} = 0V$, $V_{CM} = 0V$, $V_{OUT} = V_{DD}/2$, R_L tied to $V_{DD}/2$, input noise floor of test equipment = $10nV/\sqrt{Hz}$ for all distortion measurements, $T_A = +25^\circ C$, unless otherwise noted.)

INPUT OFFSET VOLTAGE DISTRIBUTION

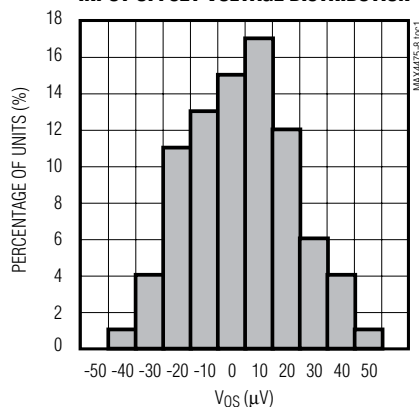

OFFSET VOLTAGE vs. TEMPERATURE

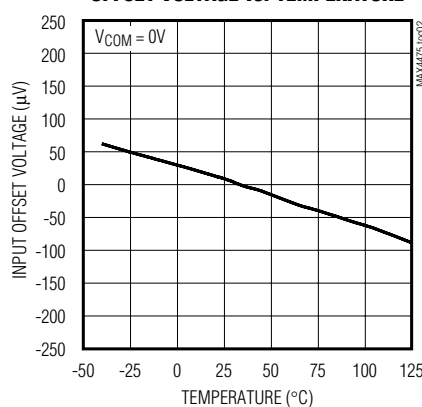

INPUT OFFSET VOLTAGE vs. INPUT COMMON-MODE VOLTAGE

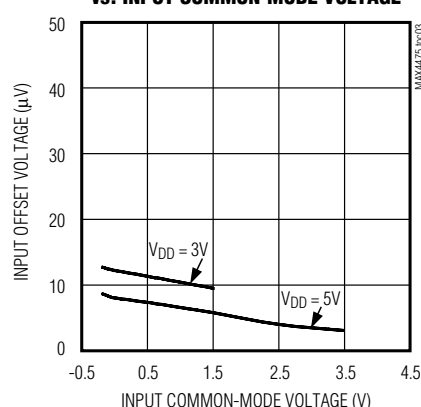

MAX4475-MAX4478/MAX4488/MAX4489

SOT23, Low-Noise, Low-Distortion, Wide-Band, Rail-to-Rail Op Amps

Typical Operating Characteristics (continued)

($V_{DD} = +5V$, $V_{SS} = 0V$, $V_{CM} = 0V$, $V_{OUT} = V_{DD}/2$, R_L tied to $V_{DD}/2$, input noise floor of test equipment = $10nV/\sqrt{Hz}$ for all distortion measurements, $T_A = +25^\circ C$, unless otherwise noted.)

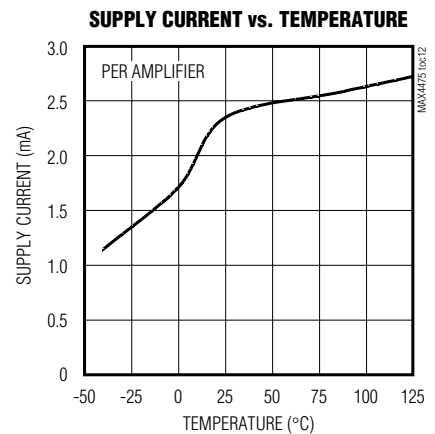
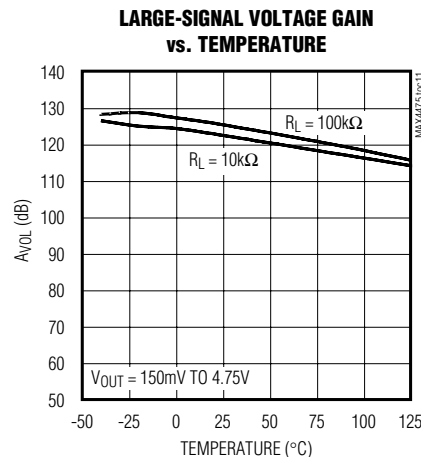
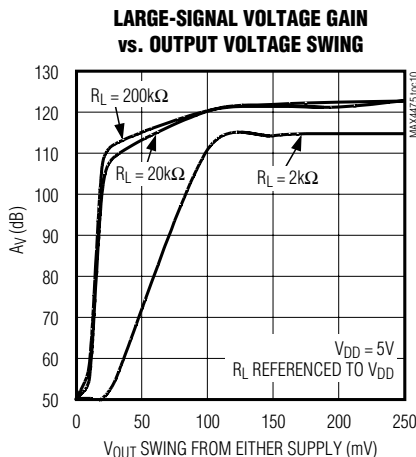
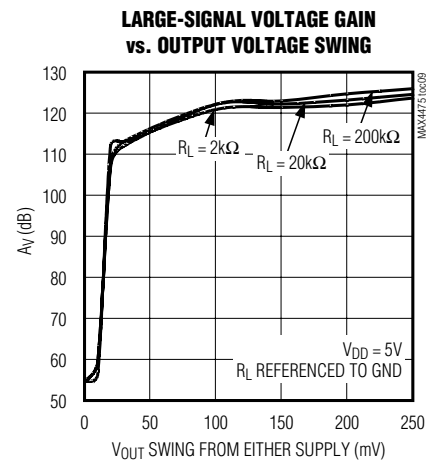
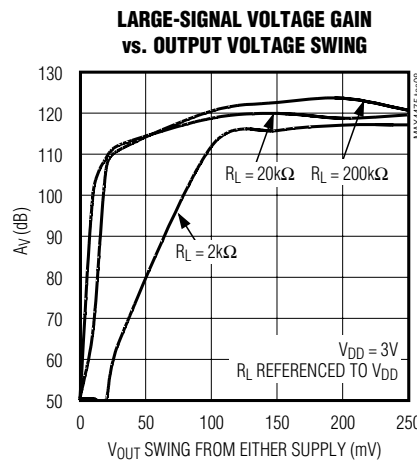
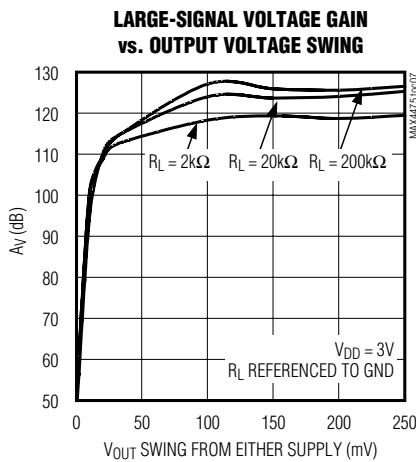
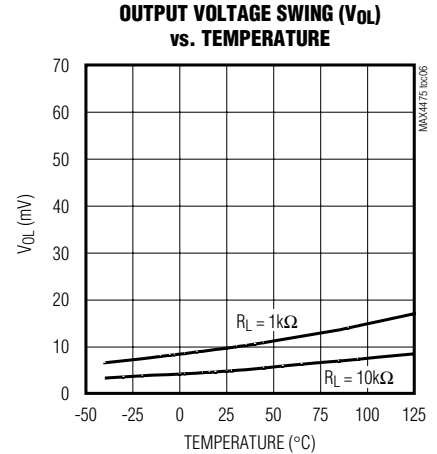
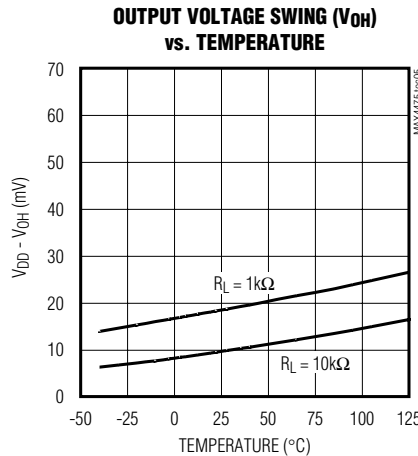
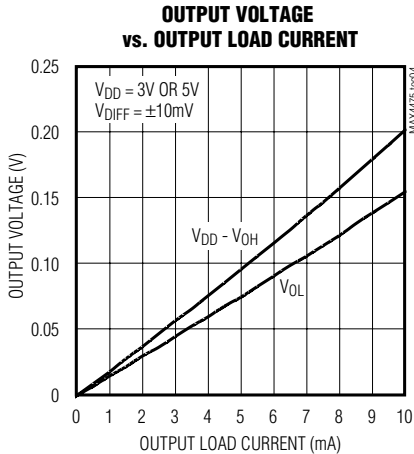

MAX4475-MAX4478/MAX4488/MAX4489

SOT23, Low-Noise, Low-Distortion, Wide-Band, Rail-to-Rail Op Amps

Typical Operating Characteristics (continued)

($V_{DD} = +5V$, $V_{SS} = 0V$, $V_{CM} = 0V$, $V_{OUT} = V_{DD}/2$, R_L tied to $V_{DD}/2$, input noise floor of test equipment = $10nV/\sqrt{Hz}$ for all distortion measurements, $T_A = +25^\circ C$, unless otherwise noted.)

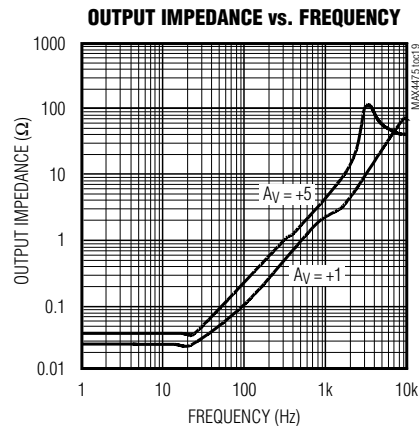
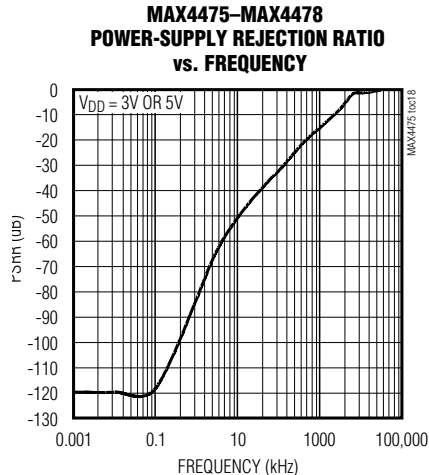
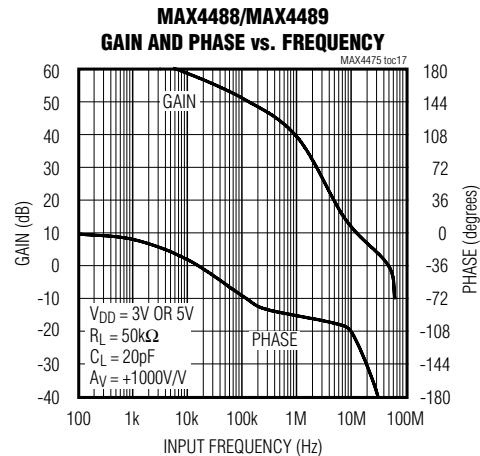
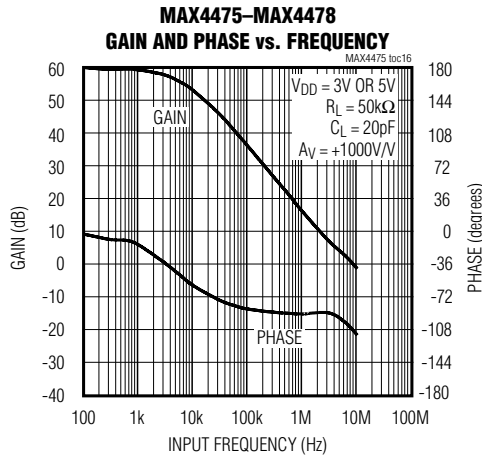
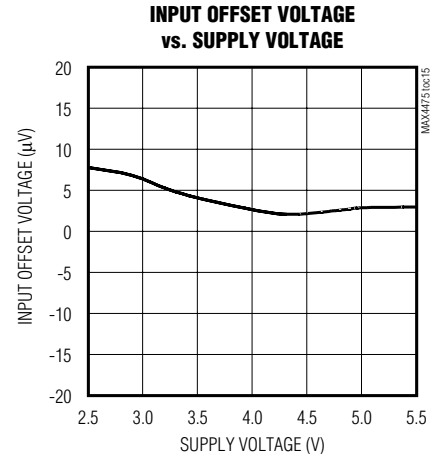
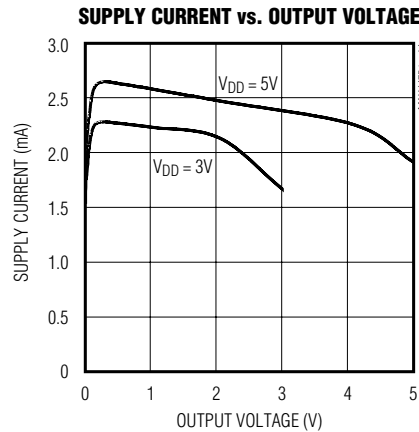
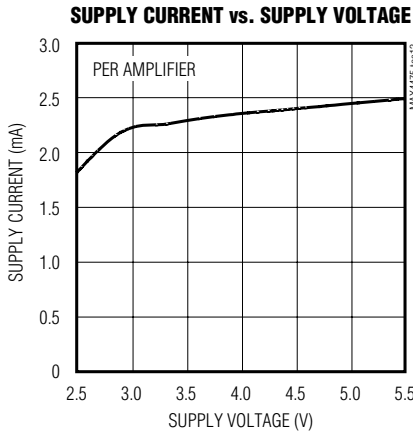

MAX4475-MAX4478/MAX4488/MAX4489

SOT23, Low-Noise, Low-Distortion, Wide-Band, Rail-to-Rail Op Amps

Typical Operating Characteristics (continued)

($V_{DD} = +5V$, $V_{SS} = 0V$, $V_{CM} = 0V$, $V_{OUT} = V_{DD}/2$, R_L tied to $V_{DD}/2$, input noise floor of test equipment = $10nV/\sqrt{Hz}$ for all distortion measurements, $T_A = +25^\circ C$, unless otherwise noted.)

INPUT VOLTAGE-NOISE DENSITY vs. FREQUENCY

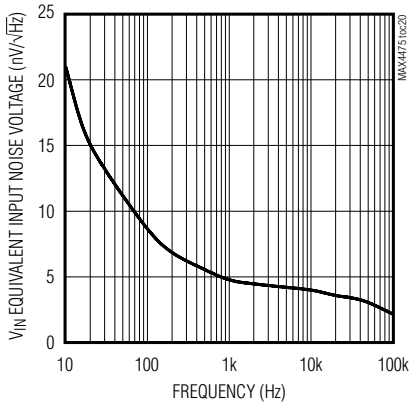

0.1Hz TO 10Hzp-p NOISE

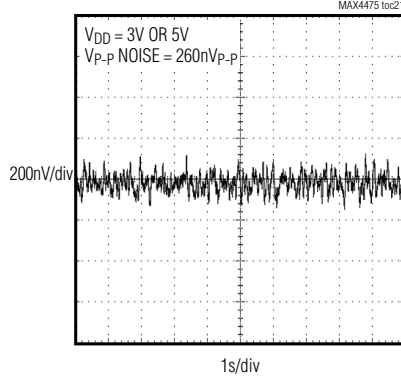

MAX4475 TOTAL HARMONIC DISTORTION PLUS NOISE vs. OUTPUT VOLTAGE SWING

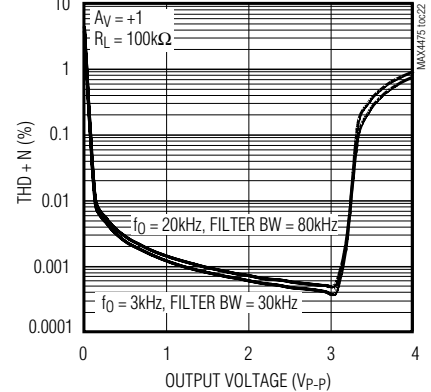

MAX4488/MAX4489 TOTAL HARMONIC DISTORTION PLUS NOISE vs. OUTPUT VOLTAGE SWING

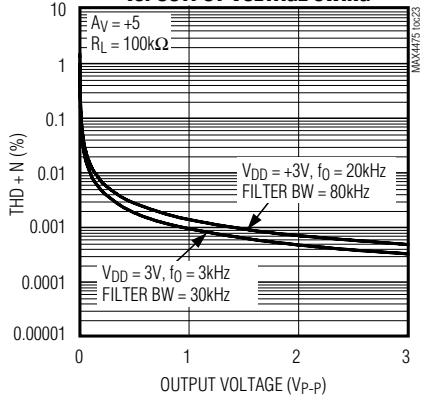

MAX4488/MAX4489 TOTAL HARMONIC DISTORTION PLUS NOISE vs. FREQUENCY

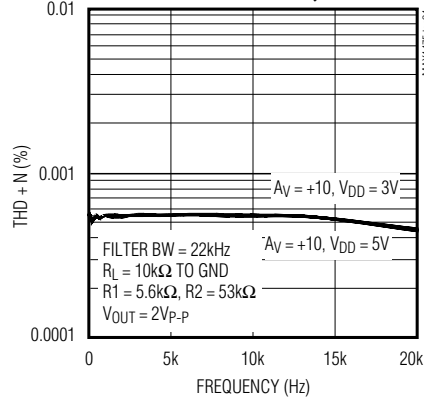

MAX4475-MAX4478 TOTAL HARMONIC DISTORTION PLUS NOISE vs. FREQUENCY

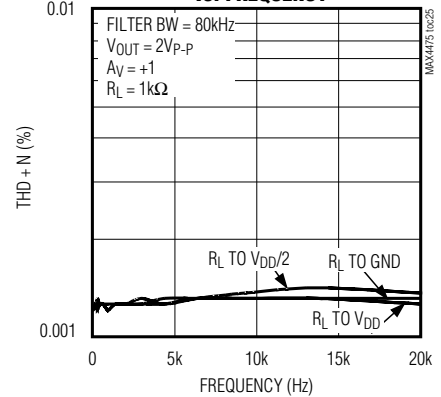

MAX4488/MAX4489 TOTAL HARMONIC DISTORTION PLUS NOISE vs. FREQUENCY

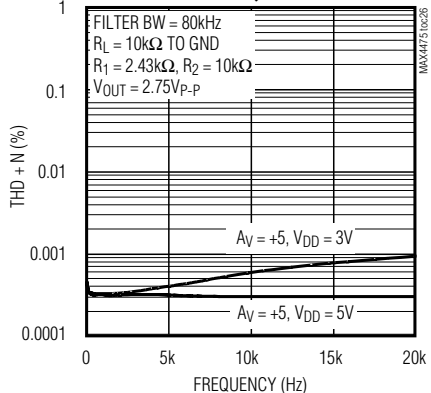

MAX4475-MAX4478 LARGE-SIGNAL PULSE RESPONSE

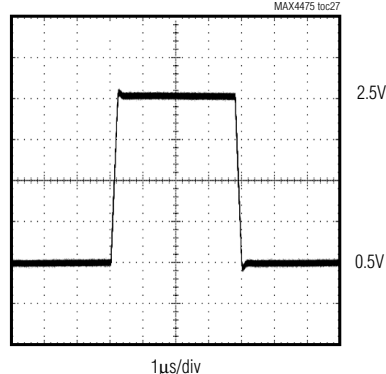

MAX4475-MAX4478 SMALL-SIGNAL PULSE RESPONSE

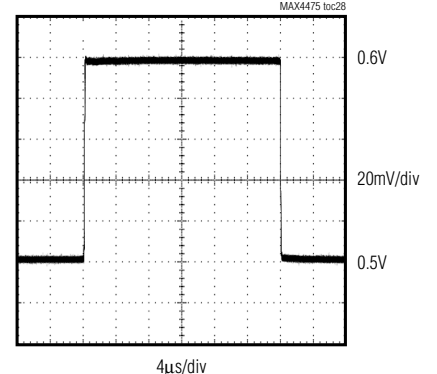

MAX4475-MAX4478/MAX4488/MAX4489

SOT23, Low-Noise, Low-Distortion, Wide-Band, Rail-to-Rail Op Amps

Typical Operating Characteristics (continued)

($V_{DD} = +5V$, $V_{SS} = 0V$, $V_{CM} = 0V$, $V_{OUT} = V_{DD}/2$, R_L tied to $V_{DD}/2$, input noise floor of test equipment = $10nV/\sqrt{Hz}$ for all distortion measurements, $T_A = +25^\circ C$, unless otherwise noted.)

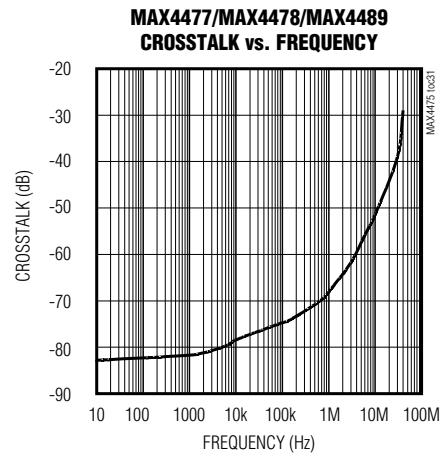
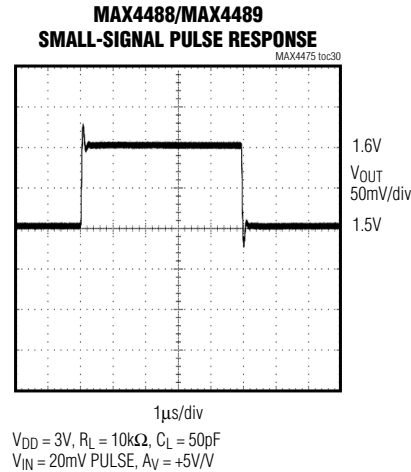
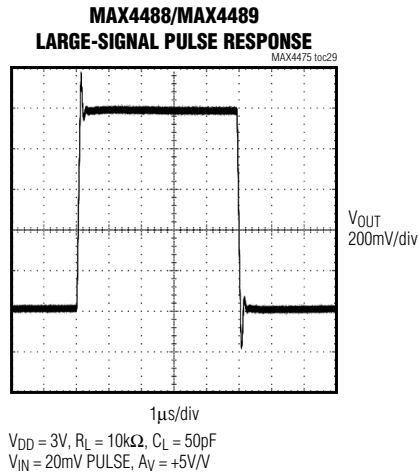

Pin Description

PIN					NAME	FUNCTION
MAX4475/ MAX4488	MAX4475/ MAX4488	MAX4476	MAX4477/ MAX4489	MAX4478		
SOT23/TDFN	SO/ μ MAX	SOT23/TDFN	SO/ μ MAX	SO/TSSOP		
1	6	1	1, 7	1, 7, 8, 14	OUT, OUTA, OUTB, OUTC, OUTD	Amplifier Output
2	4	2	4	11	V_{SS}	Negative Supply. Connect to ground for single-supply operation
3	3	3	3, 5	3, 5, 10, 12	IN+, INA+, INB+, INC+, IND+	Noninverting Amplifier Input
4	2	4	2, 6	2, 6, 9, 13	IN-, INA-, INB-, INC-, IND-	Inverting Amplifier Input
6	7	6	8	4	V_{DD}	Positive Supply
5	8	—	—	—	\overline{SHDN}	Shutdown Input. Connect to V_{DD} for normal operation (amplifier(s) enabled).
—	1, 5	5	—	—	N.C.	No Connection. Not internally connected.
EP	—	EP	—	—	EP	Exposed Paddle (TDFN Only). Connect to V_{SS} .

MAX4475–MAX4478/MAX4488/MAX4489

SOT23, Low-Noise, Low-Distortion, Wide-Band, Rail-to-Rail Op Amps

Detailed Description

The MAX4475–MAX4478/MAX4488/MAX4489 single-supply operational amplifiers feature ultra-low noise and distortion. Their low distortion and low noise make them ideal for use as preamplifiers in wide dynamic-range applications, such as 16-bit analog-to-digital converters (see *Typical Operating Circuit*). Their high-input impedance and low noise are also useful for signal conditioning of high-impedance sources, such as piezoelectric transducers.

These devices have true rail-to-rail output operation, drive loads as low as $1\text{k}\Omega$ while maintaining DC accuracy, and can drive capacitive loads up to 200pF without oscillation. The input common-mode voltage range extends from $(V_{DD} - 1.6\text{V})$ to 200mV below the negative rail. The push-pull output stage maintains excellent DC characteristics, while delivering up to $\pm 5\text{mA}$ of current.

The MAX4475–MAX4478 are unity-gain stable, while the MAX4488/MAX4489 have a higher slew rate and are stable for gains $\geq 5\text{V/V}$. The MAX4475/MAX4488 feature a low-power shutdown mode, which reduces the supply current to $0.01\mu\text{A}$ and disables the outputs.

Low Distortion

Many factors can affect the noise and distortion that the device contributes to the input signal. The following guidelines offer valuable information on the impact of design choices on Total Harmonic Distortion (THD).

Choosing proper feedback and gain resistor values for a particular application can be a very important factor in reducing THD. In general, the smaller the closed-loop gain, the smaller the THD generated, especially when driving heavy resistive loads. The THD of the part normally increases at approximately 20dB per decade, as a function of frequency. Operating the device near or above the full-power bandwidth significantly degrades distortion.

Referencing the load to either supply also improves the part's distortion performance, because only one of the MOSFETs of the push-pull output stage drives the output. Referencing the load to midsupply increases the part's distortion for a given load and feedback setting. (See the Total Harmonic Distortion vs. Frequency graph in the *Typical Operating Characteristics*.)

For gains $\geq 5\text{V/V}$, the decompensated devices MAX4488/MAX4489 deliver the best distortion performance, since they have a higher slew rate and provide a higher amount of loop gain for a given closed-loop gain setting. Capacitive loads below 100pF do not significantly affect distortion results. Distortion performance is relatively constant over supply voltages.

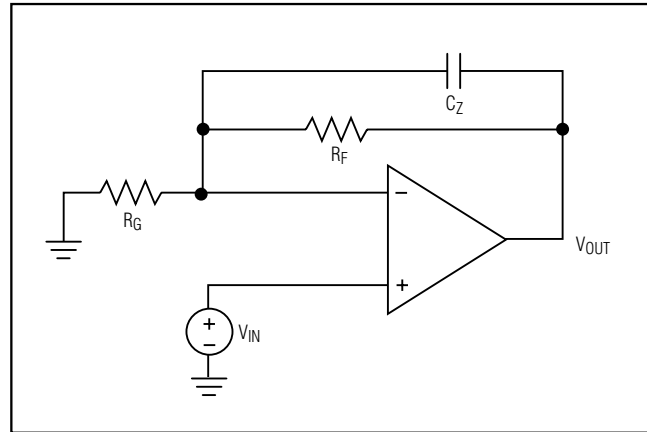

Figure 1. Adding Feed-Forward Compensation

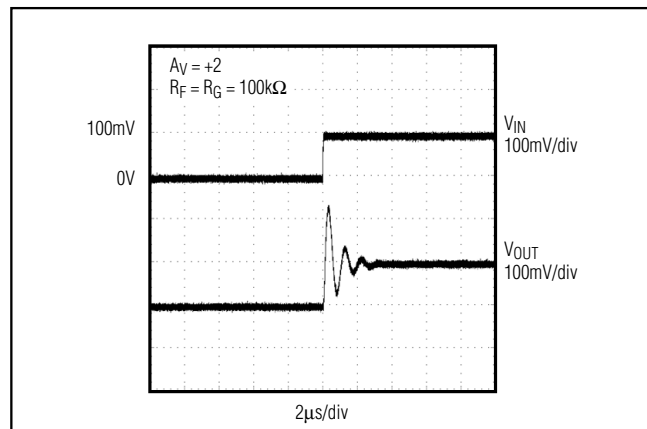

Figure 2a. Pulse Response with No Feed-Forward Compensation

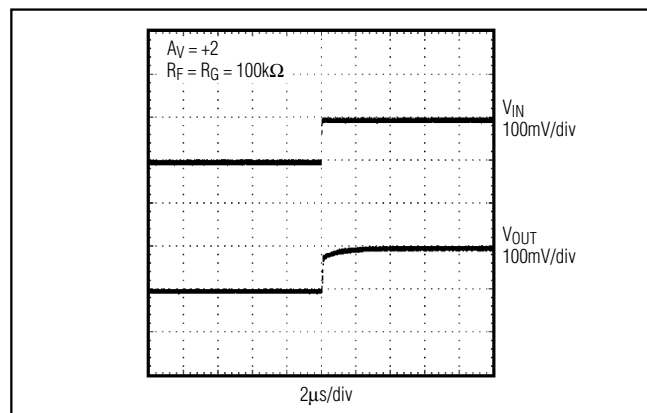

Figure 2b. Pulse Response with 10pF Feed-Forward Compensation

MAX4475-MAX4478/MAX4488/MAX4489

SOT23, Low-Noise, Low-Distortion, Wide-Band, Rail-to-Rail Op Amps

Low Noise

The amplifier's input-referred noise-voltage density is dominated by flicker noise at lower frequencies, and by thermal noise at higher frequencies. Because the thermal noise contribution is affected by the parallel combination of the feedback resistive network ($R_F \parallel R_G$, Figure 1), these resistors should be reduced in cases where the system bandwidth is large and thermal noise is dominant. This noise contribution factor decreases, however, with increasing gain settings.

For example, the input noise-voltage density of the circuit with $R_F = 100\text{k}\Omega$, $R_G = 11\text{k}\Omega$ ($A_V = +5\text{V/V}$) is $e_n = 14\text{nV}/\sqrt{\text{Hz}}$, e_n can be reduced to $6\text{nV}/\sqrt{\text{Hz}}$ by choosing $R_F = 10\text{k}\Omega$, $R_G = 1.1\text{k}\Omega$ ($A_V = +5\text{V/V}$), at the expense of greater current consumption and potentially higher distortion. For a gain of 100V/V with $R_F = 100\text{k}\Omega$, $R_G = 1.1\text{k}\Omega$, the e_n is still a low $6\text{nV}/\sqrt{\text{Hz}}$.

Using a Feed-Forward Compensation Capacitor, C_Z

The amplifier's input capacitance is 10pF . If the resistance seen by the inverting input is large (feedback network), this can introduce a pole within the amplifier's bandwidth resulting in reduced phase margin. Compensate the reduced phase margin by introducing a feed-forward capacitor (C_Z) between the inverting input and the output (Figure 1). This effectively cancels the pole from the inverting input of the amplifier. Choose the value of C_Z as follows:

$$C_Z = 10 \times (R_F / R_G) \text{ [pF]}$$

In the unity-gain stable MAX4475-MAX4478, the use of a proper C_Z is most important for $A_V = +2\text{V/V}$, and $A_V = -1\text{V/V}$. In the decompensated MAX4488/MAX4489, C_Z is most important for $A_V = +10\text{V/V}$. Figures 2a and 2b show transient response both with and without C_Z .

Using a slightly smaller C_Z than suggested by the formula above achieves a higher bandwidth at the expense of reduced phase and gain margin. As a general guideline, consider using C_Z for cases where $R_G \parallel R_F$ is greater than $20\text{k}\Omega$ (MAX4475-MAX4478) or greater than $5\text{k}\Omega$ (MAX4488/MAX4489).

Applications Information

The MAX4475-MAX4478/MAX4488/MAX4489 combine good driving capability with ground-sensing input and rail-to-rail output operation. With their low distortion and low noise, they are ideal for use in ADC buffers, medical instrumentation systems and other noise-sensitive applications.

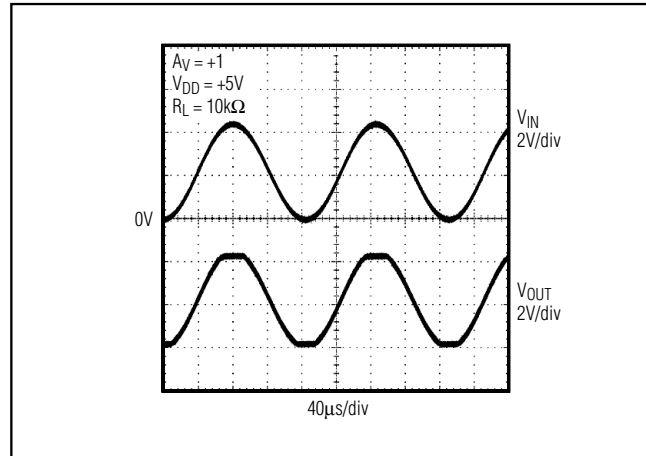

Figure 3. Overdriven Input Showing No Phase Reversal

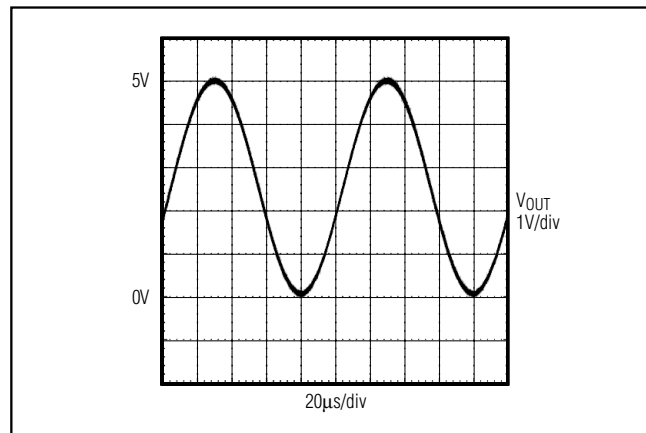

Figure 4. Rail-to-Rail Output Operation

Ground-Sensing and Rail-to-Rail Outputs

The common-mode input range of these devices extends below ground, and offers excellent common-mode rejection. These devices are guaranteed not to undergo phase reversal when the input is overdriven (Figure 3).

Figure 4 showcases the true rail-to-rail output operation of the amplifier, configured with $A_V = 5\text{V/V}$. The output swings to within 8mV of the supplies with a $10\text{k}\Omega$ load, making the devices ideal in low-supply voltage applications.

Power Supplies and Layout

The MAX4475-MAX4478/MAX4488/MAX4489 operate from a single $+2.7\text{V}$ to $+5.5\text{V}$ power supply or from dual supplies of $\pm 1.35\text{V}$ to $\pm 2.75\text{V}$. For single-supply operation, bypass the power supply with a $0.1\mu\text{F}$ ceramic

MAX4475-MAX4478/MAX4488/MAX4489

SOT23, Low-Noise, Low-Distortion, Wide-Band, Rail-to-Rail Op Amps

Typical Application Circuit

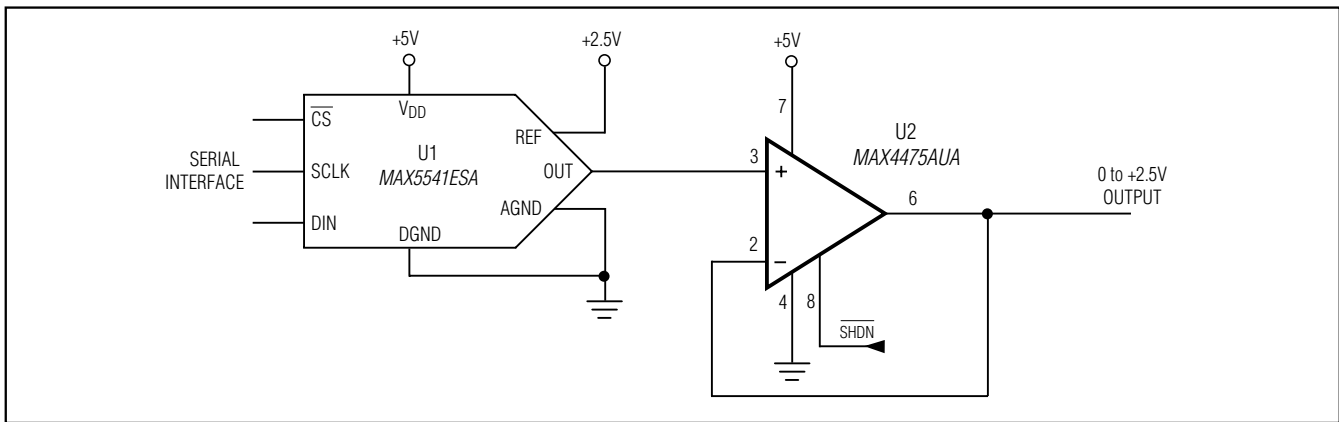

Typical Operating Circuit

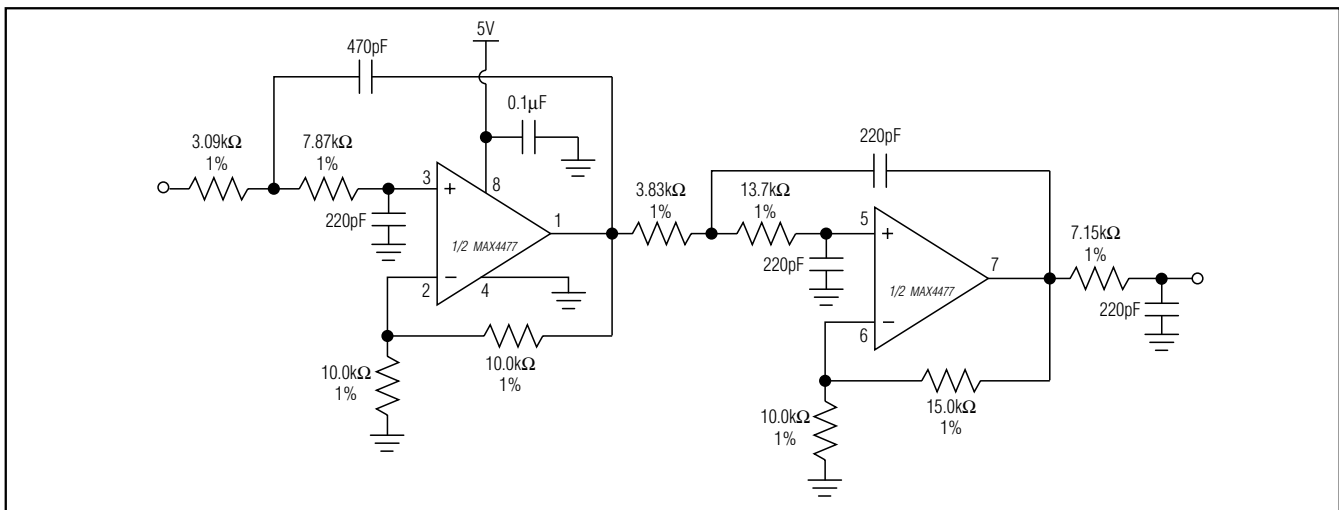

capacitor placed close to the VDD pin. If operating from dual supplies, bypass each supply to ground.

Good layout improves performance by decreasing the amount of stray capacitance and noise at the op amp's inputs and output. To decrease stray capacitance, minimize PC board trace lengths and resistor leads, and place external components close to the op amp's pins.

Typical Application Circuit

The *Typical Application Circuit* shows the single MAX4475 configured as an output buffer for the MAX5541 16-bit DAC. Because the MAX5541 has an unbuffered voltage output, the input bias current of the op amp used must be less than 6nA to maintain 16-bit accuracy. The MAX4475 has an input bias current of only 150pA (max), virtually eliminating this as a source

of error. In addition, the MAX4475 has excellent open-loop gain and common-mode rejection, making this an excellent output buffer amplifier.

DC-Accurate Lowpass Filter

The MAX4475-MAX4478/MAX4488/MAX4489 offer a unique combination of low noise, wide bandwidth, and high gain, making them an excellent choice for active filters up to 1MHz. The *Typical Operating Circuit* shows the dual MAX4477 configured as a 5th order Chebyshev filter with a cutoff frequency of 100kHz. The circuit is implemented in the Sallen-Key topology, making this a DC-accurate filter.

MAX4475-MAX4478/MAX4488/MAX4489

SOT23, Low-Noise, Low-Distortion, Wide-Band, Rail-to-Rail Op Amps

Pin Configurations

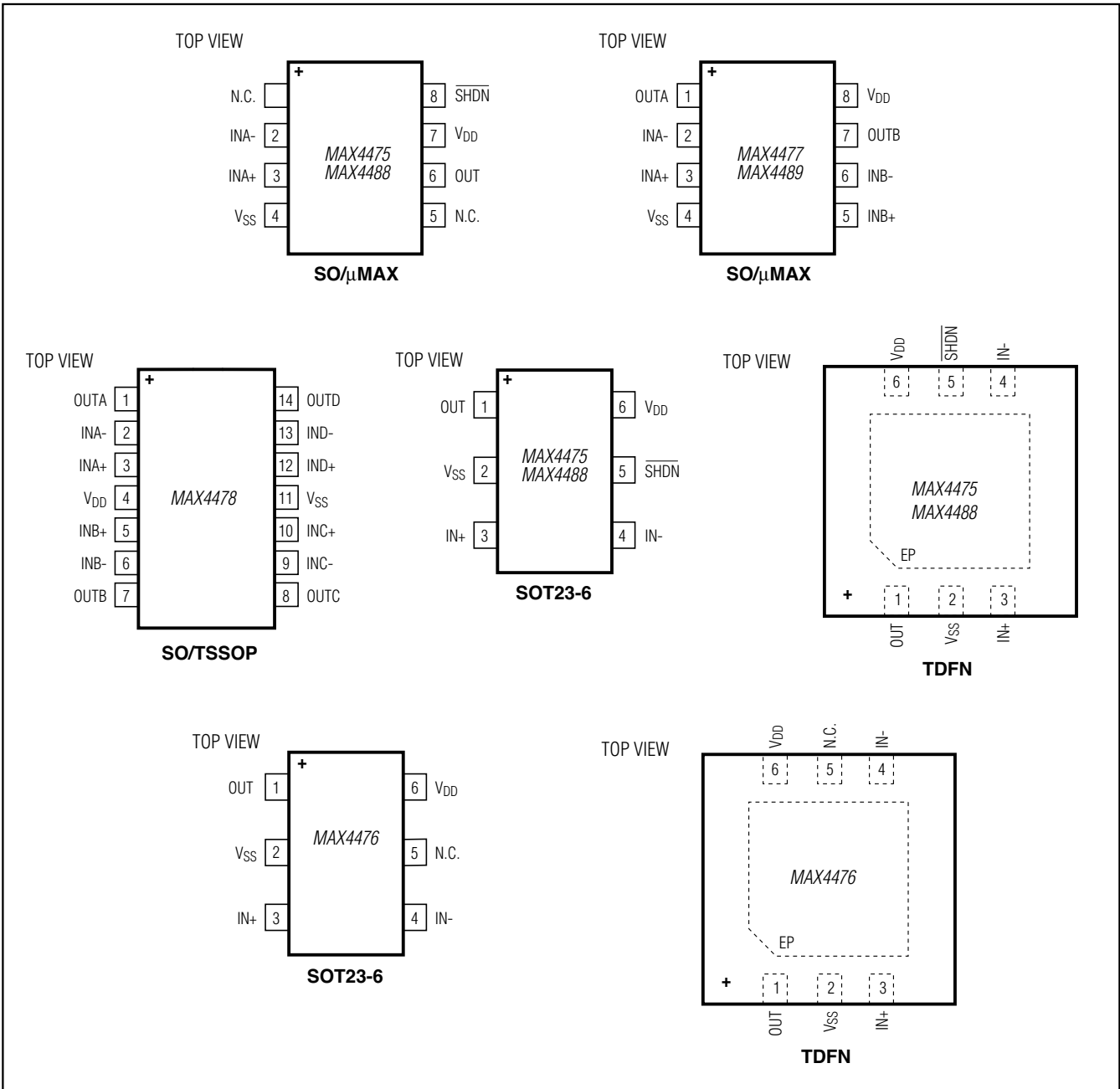

MAX4475-MAX4478/MAX4488/MAX4489

SOT23, Low-Noise, Low-Distortion, Wide-Band, Rail-to-Rail Op Amps

Ordering Information (continued)

PART	TEMP RANGE	PIN-PACKAGE	TOP MARK
MAX4476 AUT+T	-40°C to +125°C	6 SOT23	AAZX
MAX4476ATT+T	-40°C to +125°C	6 TDFN-EP*	+ADF
MAX4477 AUA+	-40°C to +125°C	8 μ MAX	—
MAX4477AUA+	-40°C to +125°C	8 μ MAX	—
MAX4477ASA+	-40°C to +125°C	8 SO	—
MAX4478 AUD+	-40°C to +125°C	14 TSSOP	—
MAX4478AUD/V+	-40°C to +125°C	14 TSSOP	—
MAX4478ASD+	-40°C to +125°C	14 SO	—
MAX4488 AUT+T	-40°C to +125°C	6 SOT23	AAZW
MAX4488AUA+	-40°C to +125°C	8 μ MAX	—
MAX4488ASA+	-40°C to +125°C	8 SO	—
MAX4488ATT+T	-40°C to +125°C	6 TDFN-EP*	+ADE
MAX4489 AUA+	-40°C to +125°C	8 μ MAX	—
MAX4489AUA/V+T	-40°C to +125°C	8 μ MAX	—
MAX4489ASA+	-40°C to +125°C	8 SO	—

+Denotes a lead(Pb)-free/RoHS-compliant package.

*EP = Exposed pad (connect to V_{SS}).

/V denotes an automotive qualified part.

T = Tape and reel.

Chip Information

PROCESS: BICMOS

MAX4475-MAX4478/MAX4488/MAX4489

SOT23, Low-Noise, Low-Distortion, Wide-Band, Rail-to-Rail Op Amps

Package Information

For the latest package outline information and land patterns (footprints), go to www.maximintegrated.com/packages. Note that a "+", "#", or "-" in the package code indicates RoHS status only. Package drawings may show a different suffix character, but the drawing pertains to the package regardless of RoHS status.

PACKAGE TYPE	PACKAGE CODE	OUTLINE NO.	LAND PATTERN NO.
6 SOT23	U6F+6	21-0058	90-0175
8 μ MAX	U8+1	21-0036	90-0092
14 TSSOP	U14+2	21-0066	90-0117
8 SO	S8+4	21-0041	—
14 SO	S14+4	21-0041	—
6 TDFN-EP	T633+2	21-0137	90-0058

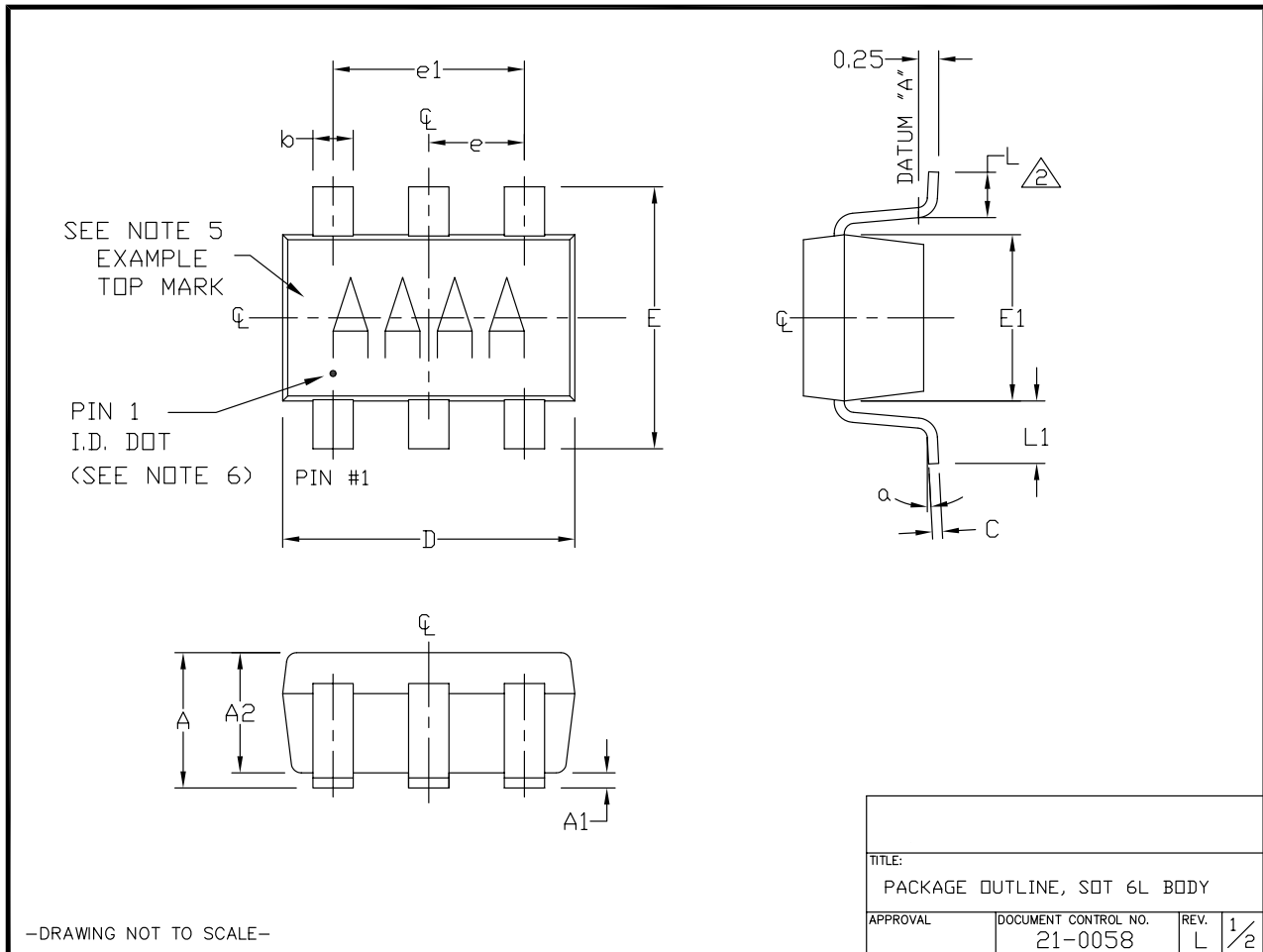

MAX4475-MAX4478/MAX4488/MAX4489

SOT23, Low-Noise, Low-Distortion, Wide-Band, Rail-to-Rail Op Amps

Package Information (continued)

For the latest package outline information and land patterns (footprints), go to www.maximintegrated.com/packages. Note that a "+", "#", or "-" in the package code indicates RoHS status only. Package drawings may show a different suffix character, but the drawing pertains to the package regardless of RoHS status.

NOTES:

1. ALL DIMENSIONS ARE IN MILLIMETERS.
2.  FOOT LENGTH MEASURED AT INTERCEPT POINT BETWEEN DATUM A & LEAD SURFACE.
3. PACKAGE OUTLINE EXCLUSIVE OF MOLD FLASH & METAL BURR. MOLD FLASH, PROTRUSION OR METAL BURR SHOULD NOT EXCEED 0.25mm.
4. PACKAGE OUTLINE INCLUSIVE OF SOLDER PLATING.
5. PIN 1 IS LOWER LEFT PIN WHEN READING TOP MARK FROM LEFT TO RIGHT. (SEE EXAMPLE TOP MARK)
6. PIN 1 I.D. DOT IS 0.3mm \varnothing MIN. LOCATED ABOVE PIN 1.
7. MEETS JEDEC MO178, VARIATION AB.
8. SOLDER THICKNESS MEASURED AT FLAT SECTION OF LEAD BETWEEN 0.08mm AND 0.15mm FROM LEAD TIP.
9. LEAD TO BE COPLANAR WITHIN 0.1mm.
10. NUMBER OF LEADS SHOWN ARE FOR REFERENCE ONLY.
11. MARKING IS FOR PACKAGE ORIENTATION REFERENCE ONLY.
12. ALL DIMENSIONS APPLY TO BOTH LEADED (-) AND PbFREE (+) PKG. CODES.

SYMBOL	MIN	NOMINAL	MAX
A	0.90	1.25	1.45
A1	0.00	0.05	0.15
A2	0.90	1.10	1.30
b	0.35	0.40	0.50
C	0.08	0.15	0.20
D	2.80	2.90	3.00
E	2.60	2.80	3.00
E1	1.50	1.625	1.75
L	0.35	0.45	0.60
L1	0.60 REF.		
e1	1.90 BSC.		
e	0.95 BSC.		
α	0°	2.5°	10°

PKG CODES:
U6-1, U6-2, U6-4, U6CN-2,
U6SN-1, U6F-6, U6FH-6; U6FH-7

** U6FH-7 TO BE USED FOR NP42 PARTS ONLY.

-DRAWING NOT TO SCALE-

TITLE:		
PACKAGE OUTLINE, SOT 6L BODY		
APPROVAL	DOCUMENT CONTROL NO.	REV.
	21-0058	L 2/2

MAX4475-MAX4478/MAX4488/MAX4489

SOT23, Low-Noise, Low-Distortion, Wide-Band, Rail-to-Rail Op Amps

Package Information (continued)

For the latest package outline information and land patterns (footprints), go to www.maximintegrated.com/packages. Note that a "+", "#", or "-" in the package code indicates RoHS status only. Package drawings may show a different suffix character, but the drawing pertains to the package regardless of RoHS status.

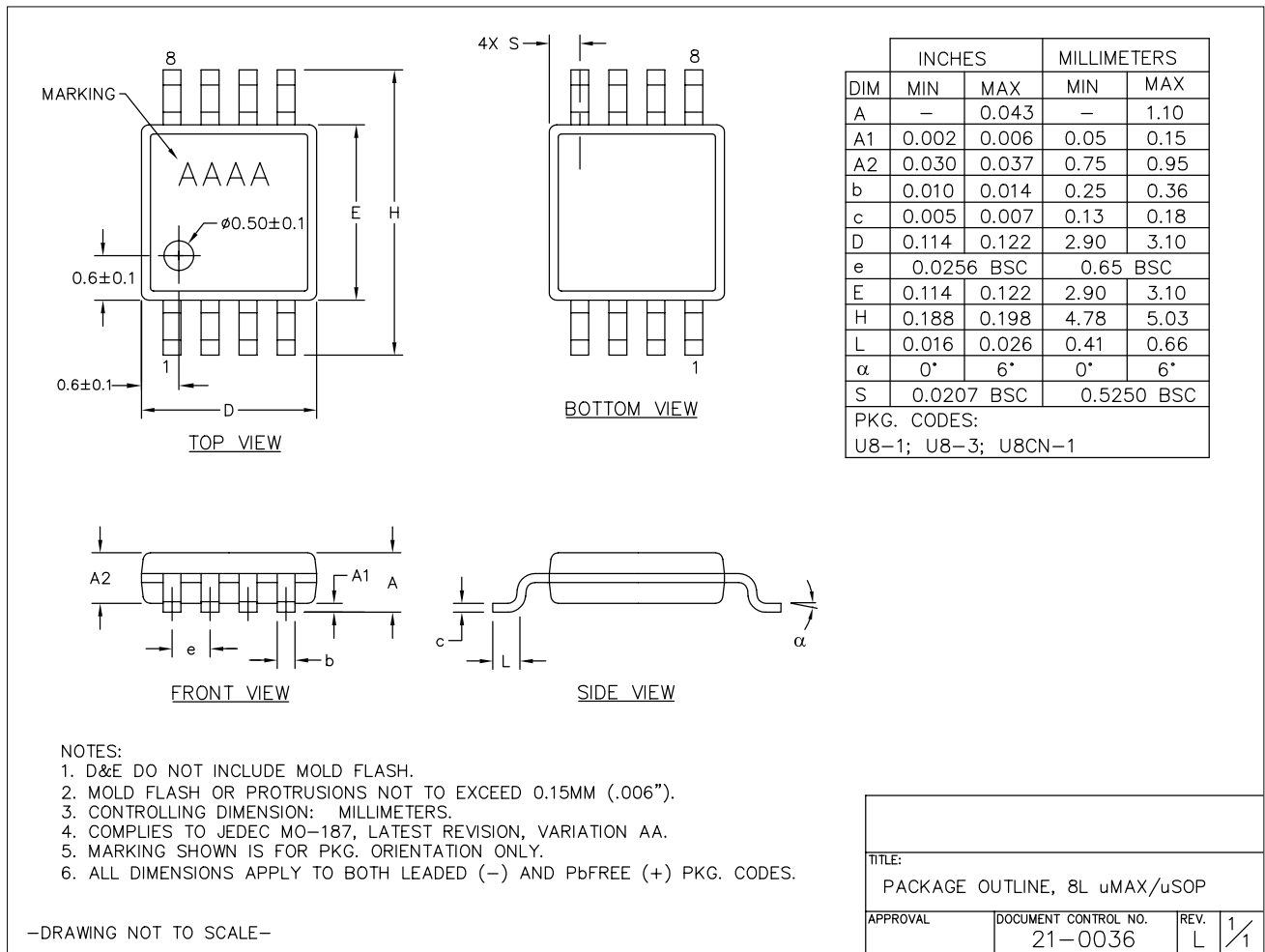

MAX4475-MAX4478/MAX4488/MAX4489

SOT23, Low-Noise, Low-Distortion, Wide-Band, Rail-to-Rail Op Amps

Package Information (continued)

For the latest package outline information and land patterns (footprints), go to www.maximintegrated.com/packages. Note that a "+", "#", or "-" in the package code indicates RoHS status only. Package drawings may show a different suffix character, but the drawing pertains to the package regardless of RoHS status.

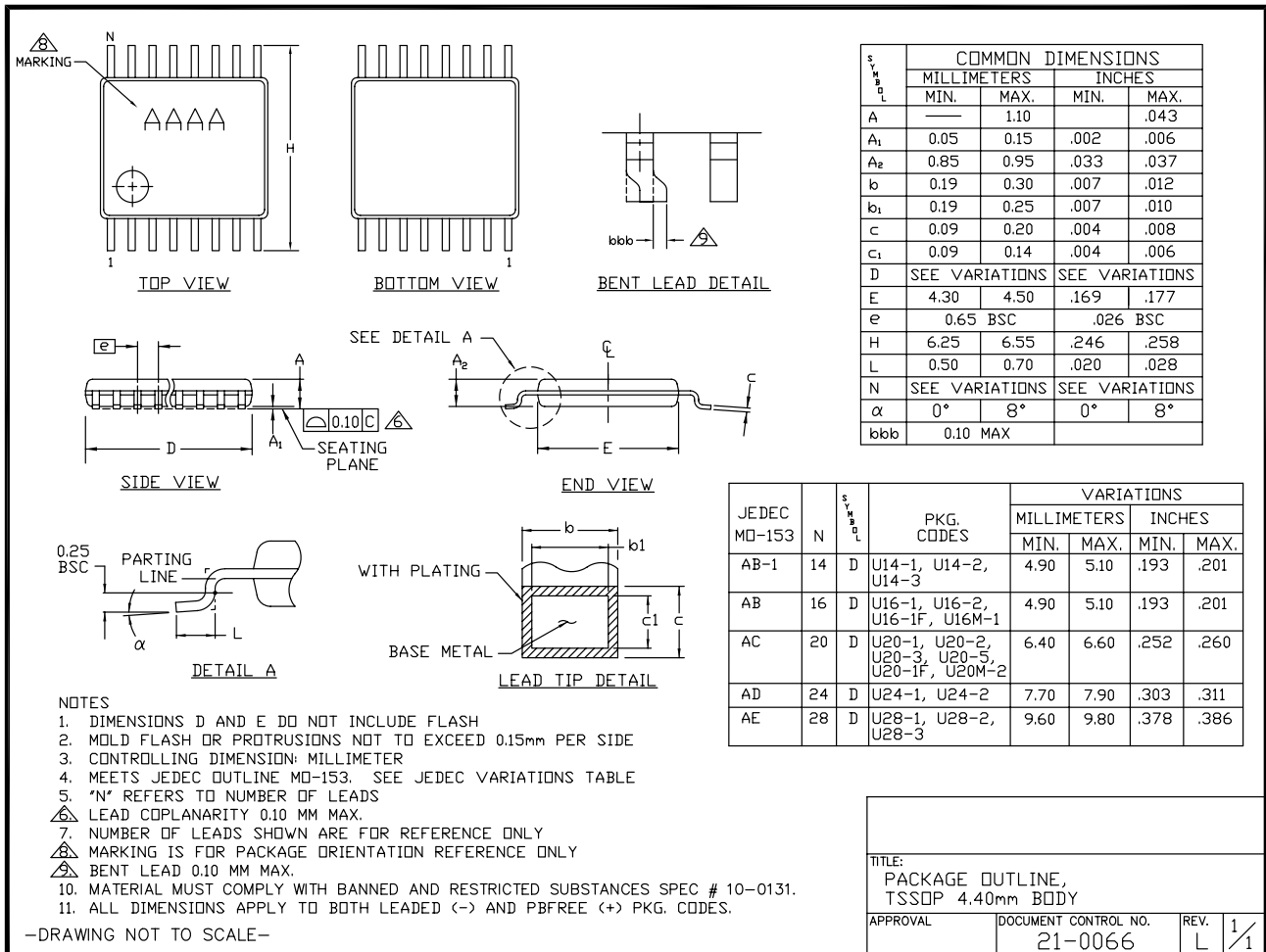

MAX4475-MAX4478/MAX4488/MAX4489

SOT23, Low-Noise, Low-Distortion, Wide-Band, Rail-to-Rail Op Amps

Package Information (continued)

For the latest package outline information and land patterns (footprints), go to www.maximintegrated.com/packages. Note that a "+", "#", or "-" in the package code indicates RoHS status only. Package drawings may show a different suffix character, but the drawing pertains to the package regardless of RoHS status.

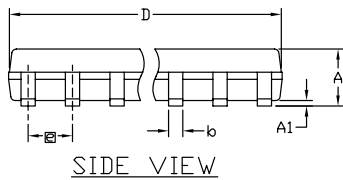
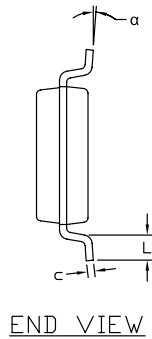
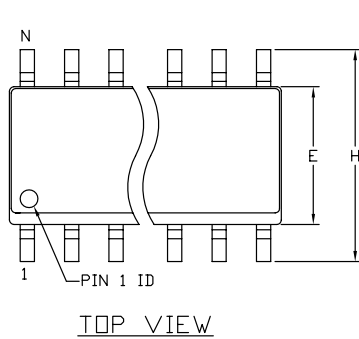

SYMBOL	INCHES		MM	
	MIN.	MAX.	MIN.	MAX.
A	.053	.069	1.35	1.75
A1	.004	.010	0.10	0.25
b	.014	.019	0.35	0.49
c	.007	.010	0.19	0.25
E	.150	.157	3.80	4.00
e	.050 BSC		1.27 BSC	
H	.228	.244	5.80	6.20
L	.016	.050	0.40	1.27
α	0°	8°	0°	8°

VARIATION A				
SYMBOL	INCHES		MM	
	MIN.	MAX.	MIN.	MAX.
D	.189	.197	4.80	5.00
N	8			
MS012	AA			
PKG. CODE	S8-2, S8-4, S8-5, S8-6F, S8-7F, S8-8F, S8-10F, S8-11F, S8-16F			

VARIATION B				
SYMBOL	INCHES		MM	
	MIN.	MAX.	MIN.	MAX.
D	.337	.344	8.55	8.75
N	14			
MS012	AB			
PKG. CODE	S14-1, S14-4, S14-5, S14-6, S14M-4, S14M-5, S14M-6, S14M-7			

VARIATION C				
SYMBOL	INCHES		MM	
	MIN.	MAX.	MIN.	MAX.
D	.386	.394	9.80	10.00
N	16			
MS012	AC			
PKG. CODE	S16-1, S16-3, S16-5, S16-6, S16-8, S16-7F, S16-9F, S16-10F; S16M-3, S16M-6			

NOTES:

1. ALL DIMENSIONS ARE IN MILLIMETERS UNLESS OTHERWISE SPECIFIED.
2. MATERIAL MUST COMPLY WITH BANNED AND RESTRICTED SUBSTANCES SPEC # 10-0131.
3. DIMENSIONS D AND E DO NOT INCLUDE MOLD PROTRUSION. ALLOWABLE MOLD PROTRUSION IS 0.15 MM (.006") PER SIDE.
4. LEADS TO BE COPLANAR WITHIN 0.10mm (.004").
5. MEETS JEDEC MS012
6. ALL DIMENSIONS APPLY TO BOTH LEADED (-) AND PbFREE (+) PKG. CODES.

-DRAWING NOT TO SCALE-

TITLE: PACKAGE OUTLINE, 8L, 14L, 16L SOIC .150 INCH			
APPROVAL	DOCUMENT CONTROL NO. 21-0041	REV. C	1/1

MAX4475-MAX4478/MAX4488/MAX4489

SOT23, Low-Noise, Low-Distortion, Wide-Band, Rail-to-Rail Op Amps

Package Information (continued)

For the latest package outline information and land patterns (footprints), go to www.maximintegrated.com/packages. Note that a "+", "#", or "-" in the package code indicates RoHS status only. Package drawings may show a different suffix character, but the drawing pertains to the package regardless of RoHS status.

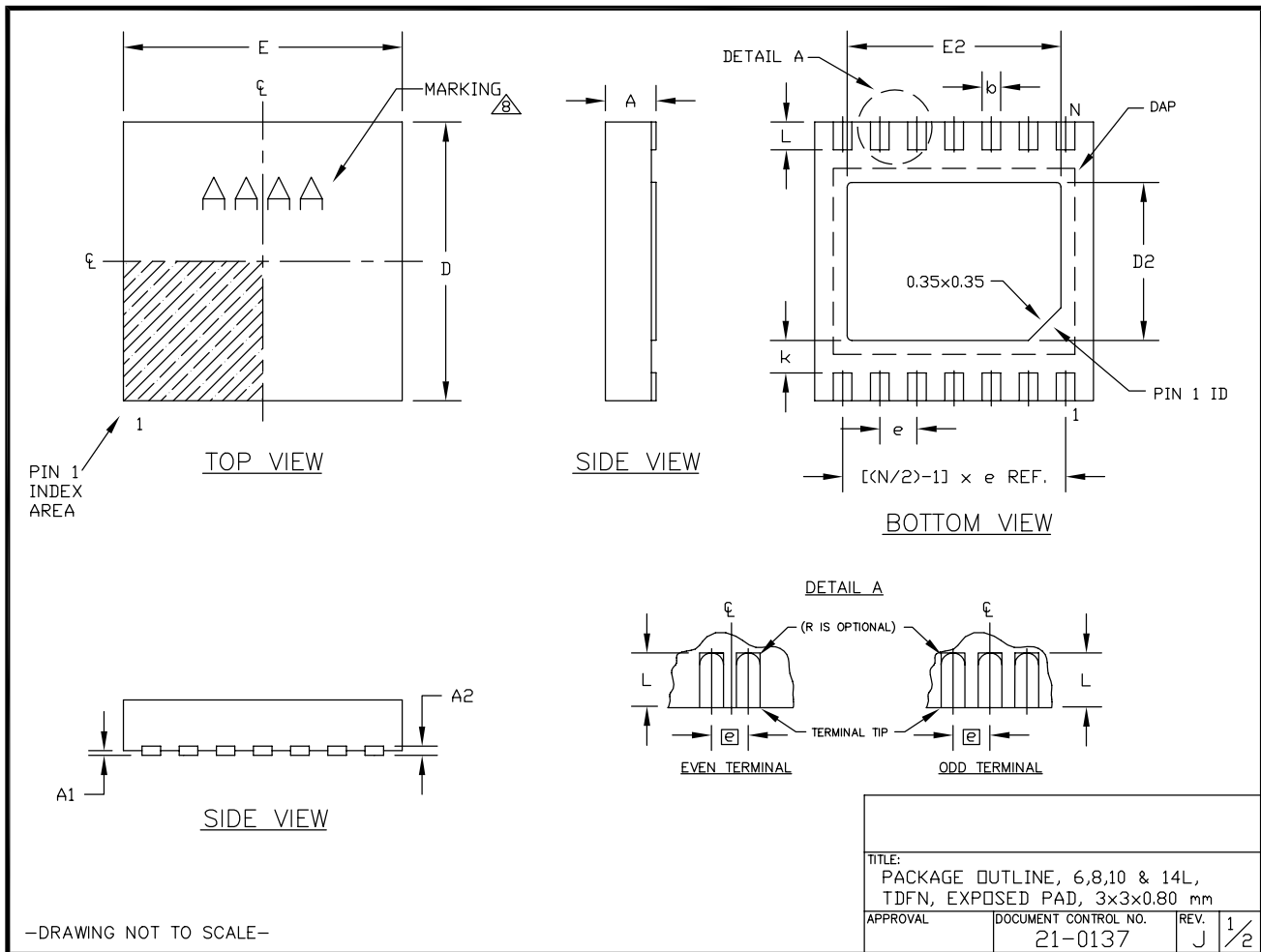

MAX4475-MAX4478/MAX4488/MAX4489

SOT23, Low-Noise, Low-Distortion, Wide-Band, Rail-to-Rail Op Amps

Package Information (continued)

For the latest package outline information and land patterns (footprints), go to www.maximintegrated.com/packages. Note that a "+", "#", or "-" in the package code indicates RoHS status only. Package drawings may show a different suffix character, but the drawing pertains to the package regardless of RoHS status.

COMMON DIMENSIONS		
SYMBOL	MIN.	MAX.
A	0.70	0.80
D	2.90	3.10
E	2.90	3.10
A1	0.00	0.05
L	0.20	0.40
k	0.25 MIN.	
A2	0.20 REF.	

PACKAGE VARIATIONS								
PKG. CODE	N	D2	E2	e	JEDEC SPEC	b	[(N/2)-1] x e	
T633-2	6	1.50±0.10	2.30±0.10	0.95 BSC	MO229 / WEEA	0.40±0.05	1.90 REF	
T833-2	8	1.50±0.10	2.30±0.10	0.65 BSC	MO229 / WEEC	0.30±0.05	1.95 REF	
T833-3	8	1.50±0.10	2.30±0.10	0.65 BSC	MO229 / WEEC	0.30±0.05	1.95 REF	
T1033-1	10	1.50±0.10	2.30±0.10	0.50 BSC	MO229 / WEED3	0.25±0.05	2.00 REF	
T1033MK-1	10	1.50±0.10	2.30±0.10	0.50 BSC	MO229 / WEED3	0.25±0.05	2.00 REF	
T1033-2	10	1.50±0.10	2.30±0.10	0.50 BSC	MO229 / WEED3	0.25±0.05	2.00 REF	
T1433-1	14	1.70±0.10	2.30±0.10	0.40 BSC	----	0.20±0.05	2.40 REF	
T1433-2	14	1.70±0.10	2.30±0.10	0.40 BSC	----	0.20±0.05	2.40 REF	
T1433-3F	14	1.70±0.10	2.30±0.10	0.40 BSC	----	0.20±0.05	2.40 REF	

NOTES:

- ALL DIMENSIONS ARE IN mm. ANGLES IN DEGREES.
- COPLANARITY SHALL NOT EXCEED 0.08 mm.
- WARPAGE SHALL NOT EXCEED 0.10 mm.
- PACKAGE LENGTH/PACKAGE WIDTH ARE CONSIDERED AS SPECIAL CHARACTERISTIC(S).
- DRAWING CONFORMS TO JEDEC MO229, EXCEPT DIMENSIONS "D2" AND "E2", AND T1433-1 & T1433-2.
- "N" IS THE TOTAL NUMBER OF LEADS.
- NUMBER OF LEADS SHOWN ARE FOR REFERENCE ONLY.
- MARKING IS FOR PACKAGE ORIENTATION REFERENCE ONLY.
- ALL DIMENSIONS APPLY TO BOTH LEADED (-) AND PbFREE (+) PKG. CODES.

-DRAWING NOT TO SCALE-

TITLE: PACKAGE OUTLINE, 6,8,10 & 14L, TDFN, EXPOSED PAD, 3x3x0.80 mm		
APPROVAL	DOCUMENT CONTROL NO. 21-0137	REV. J 2/2

MAX4475-MAX4478/MAX4488/MAX4489

SOT23, Low-Noise, Low-Distortion, Wide-Band, Rail-to-Rail Op Amps

Revision History

REVISION NUMBER	REVISION DATE	DESCRIPTION	PAGES CHANGED
4	12/09	Added lead-free designations and an automotive part to the <i>Ordering Information</i> and added input current spec in <i>Absolute Maximum Ratings</i> section	1, 2, 13
5	7/10	Added <i>N</i> designation to the MAX4475 product and soldering temperature	1, 2
6	6/12	Added <i>N</i> designation for MAX4489.	13



Maxim cannot assume responsibility for use of any circuitry other than circuitry entirely embodied in a Maxim product. No circuit patent licenses are implied. Maxim reserves the right to change the circuitry and specifications without notice at any time. The parametric values (min and max limits) shown in the Electrical Characteristics table are guaranteed. Other parametric values quoted in this data sheet are provided for guidance.

Mouser Electronics

Authorized Distributor

Click to View Pricing, Inventory, Delivery & Lifecycle Information:

Maxim Integrated:

[MAX4488AUT+T](#) [MAX4475ASA+](#) [MAX4475AUA+](#) [MAX4477ASA+](#) [MAX4477AUA+](#) [MAX4478AUD+](#)
[MAX4489AUA+](#) [MAX4475AUT+T](#) [MAX4475ASA+T](#) [MAX4475ATT+T](#) [MAX4475AUA+T](#) [MAX4476ATT+T](#)
[MAX4477ASA+T](#) [MAX4477AUA+T](#) [MAX4478ASD+](#) [MAX4478ASD+T](#) [MAX4478AUD+T](#) [MAX4488ASA+](#)
[MAX4488ASA+T](#) [MAX4488ATT+T](#) [MAX4488AUA+](#) [MAX4488AUA+T](#) [MAX4489ASA+](#) [MAX4489ASA+T](#)
[MAX4489AUA+T](#) [MAX4477ASA](#) [MAX4477ASA-T](#) [MAX4477AUA](#) [MAX4477AUA-T](#) [MAX4478ASD](#) [MAX4478ASD-T](#)
[MAX4475AUT/V+T](#) [MAX4478AUD/V+](#) [MAX4478AUD/V+T](#) [MAX4478AUD](#) [MAX4478AUD-T](#) [MAX4489ASA](#)
[MAX4489ASA-T](#) [MAX4489AUA](#) [MAX4489AUA-T](#) [MAX4476AUT+T](#)