

TYPES TIP31, TIP31A, TIP31B, TIP31C N-P-N SINGLE-DIFFUSED MESA SILICON POWER TRANSISTORS

FOR POWER-AMPLIFIER AND HIGH-SPEED-SWITCHING APPLICATIONS
DESIGNED FOR COMPLEMENTARY USE WITH TIP32, TIP32A, TIP32B, TIP32C

- 40 W at 25°C Case Temperature
- 3 A Rated Collector Current
- Min f_T of 3 MHz at 10 V, 500 mA

mechanical data

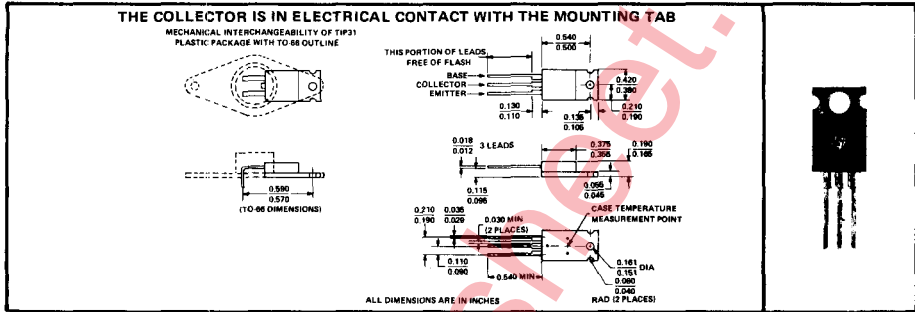

absolute maximum ratings at 25°C case temperature (unless otherwise noted)

	TIP31	TIP31A	TIP31B	TIP31C
Collector-Base Voltage	40 V	60 V	80 V	100 V
Collector-Emitter Voltage (See Note 1)	40 V	60 V	80 V	100 V
Emitter-Base Voltage	5 V			
Continuous Collector Current	3 A			
Peak Collector Current (See Note 2)	5 A			
Continuous Base Current	1 A			
Safe Operating Region at (or below) 25°C Case Temperature	See Figure 5			
Continuous Device Dissipation at (or below) 25°C Case Temperature (See Note 3)	40 W			
Continuous Device Dissipation at (or below) 25°C Free-Air Temperature (See Note 4)	2 W			
Unclamped Inductive Load Energy (See Note 5)	32 mJ			
Operating Collector Junction Temperature Range	-65°C to 150°C			
Storage Temperature Range	-65°C to 150°C			
Lead Temperature 1/8 Inch from Case for 10 Seconds	260°C			

- NOTES:
1. This value applies when the base-emitter diode is open-circuited.
 2. This value applies for $t_{BV} \leq 0.3$ ms, duty cycle $\leq 10\%$.
 3. Derate linearly to 150°C case temperature at the rate of 0.32 W/°C.
 4. Derate linearly to 150°C free-air temperature at the rate of 16 mW/°C.
 5. This rating is based on the capability of the transistor to operate safely in the circuit of Figure 2. $L = 20$ mH, $R_{BB2} = 100 \Omega$, $V_{BB2} = 0$ V, $R_S = 0.1 \Omega$, $V_{CC} = 10$ V. Energy $\approx I_C^2 L / 2$.

TYPES TIP31, TIP31A, TIP31B, TIP31C

N-P-N SINGLE-DIFFUSED MESA SILICON POWER TRANSISTORS

electrical characteristics at 25°C case temperature

PARAMETER	TEST CONDITIONS	TIP31		TIP31A		TIP31B		TIP31C		UNIT
		MIN	MAX	MIN	MAX	MIN	MAX	MIN	MAX	
$V_{(BR)CEO}$	Collector-Emitter Breakdown Voltage See Note 6	$I_C = 30 \text{ mA}, I_B = 0,$		40	60	80	100			V
I_{CEO}	Collector Cutoff Current	$V_{CE} = 30 \text{ V}, I_B = 0$		0.3	0.3					mA
		$V_{CE} = 60 \text{ V}, I_B = 0$				0.3	0.3			
I_{CES}	Collector Cutoff Current	$V_{CE} = 40 \text{ V}, V_{BE} = 0$		0.2						mA
		$V_{CE} = 60 \text{ V}, V_{BE} = 0$			0.2					
		$V_{CE} = 80 \text{ V}, V_{BE} = 0$				0.2				
		$V_{CE} = 100 \text{ V}, V_{BE} = 0$						0.2		
I_{EBO}	Emitter Cutoff Current	$V_{EB} = 5 \text{ V}, I_C = 0$		1	1	1	1			mA
h_{FE}	Static Forward Current Transfer Ratio	$V_{CE} = 4 \text{ V}, I_C = 1 \text{ A},$ See Notes 6 and 7		25	25	25	25			
		$V_{CE} = 4 \text{ V}, I_C = 3 \text{ A},$ See Notes 6 and 7		10	50	10	50	10	50	
V_{BE}	Base-Emitter Voltage	$V_{CE} = 4 \text{ V}, I_C = 3 \text{ A},$ See Notes 6 and 7		1.8	1.8	1.8	1.8			V
$V_{CE(sat)}$	Collector-Emitter Saturation Voltage	$I_B = 375 \text{ mA}, I_C = 3 \text{ A},$ See Notes 6 and 7		1.2	1.2	1.2	1.2			V
h_{fe}	Small-Signal Common-Emitter Forward Current Transfer Ratio	$V_{CE} = 10 \text{ V}, I_C = 0.5 \text{ A},$ $f = 1 \text{ kHz}$		20	20	20	20			
		$V_{CE} = 10 \text{ V}, I_C = 0.5 \text{ A},$ $f = 1 \text{ MHz}$		3	3	3	3			

NOTES: 6. These parameters must be measured using pulse techniques. $t_w = 300 \mu\text{s}$, duty cycle $\leq 2\%$.

7. These parameters are measured with voltage-sensing contacts separate from the current-carrying contacts.

thermal characteristics

PARAMETER	MAX	UNIT
$R_{\theta JC}$ Junction-to-Case Thermal Resistance	3.125	$^{\circ}\text{C/W}$
$R_{\theta JA}$ Junction-to-Free-Air Thermal Resistance	62.5	$^{\circ}\text{C/W}$

switching characteristics at 25°C case temperature

PARAMETER	TEST CONDITIONS†	TYP	UNIT
t_{on} Turn-On Time	$I_C = 1 \text{ A}, I_B(1) = 100 \text{ mA}, I_B(2) = -100 \text{ mA},$ $V_{BE(off)} = -4.3 \text{ V}, R_L = 30 \Omega,$ See Figure 1	0.5	μs
t_{off} Turn-Off Time		2	

† Voltage and current values shown are nominal; exact values vary slightly with transistor parameters.

TYPES TIP31, TIP31A, TIP31B, TIP31C N-P-N SINGLE-DIFFUSED MESA SILICON POWER TRANSISTORS

PARAMETER MEASUREMENT INFORMATION

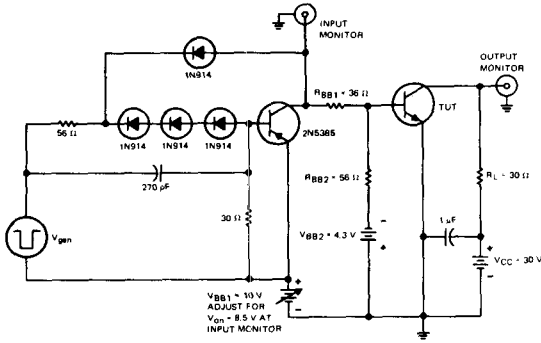

TEST CIRCUIT

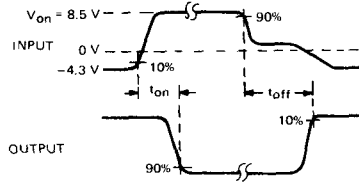

VOLTAGE WAVEFORMS

- NOTES: A. V_{gen} is a -30-V pulse (from 0 V) into a $50\text{-}\Omega$ termination.
 B. The V_{gen} waveform is supplied by a generator with the following characteristics: $t_r \leq 15\text{ ns}$, $t_f \leq 15\text{ ns}$, $Z_{out} = 50\text{ }\Omega$, $t_w = 20\text{ }\mu\text{s}$, duty cycle $\leq 2\%$.
 C. Waveforms are monitored on an oscilloscope with the following characteristics: $t_r \leq 15\text{ ns}$, $R_{in} \geq 10\text{ M}\Omega$, $C_{in} \leq 11.5\text{ pF}$.
 D. Resistors must be noninductive types.
 E. The d-c power supplies may require additional bypassing in order to minimize ringing.

FIGURE 1

INDUCTIVE LOAD SWITCHING

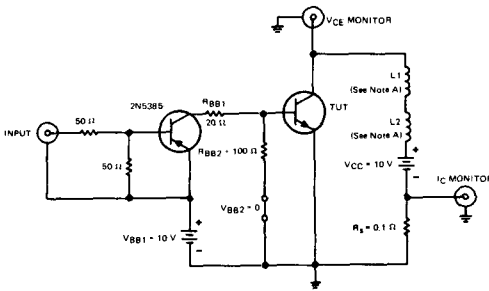

TEST CIRCUIT

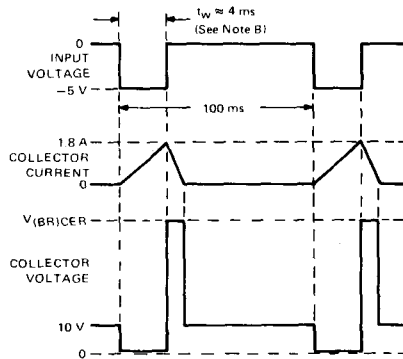

VOLTAGE AND CURRENT WAVEFORMS

- NOTES: A. L1 and L2 are 10 mH , $0.11\text{ }\Omega$, Chicago Standard Transformer Corporation C-2688, or equivalent.
 B. Input pulse width is increased until $I_{CM} = 1.8\text{ A}$.

FIGURE 2

TYPES TIP31, TIP31A, TIP31B, TIP31C

N-P-N SINGLE-DIFFUSED MESA SILICON POWER TRANSISTORS

TYPICAL CHARACTERISTICS

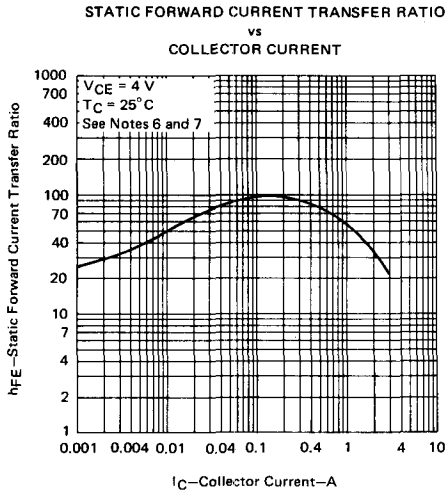

FIGURE 3

- NOTES: 6. These parameters must be measured using pulse techniques. $t_W = 300\ \mu\text{s}$, duty cycle $\leq 2\%$.
7. These parameters are measured with voltage-sensing contacts separate from the current-carrying contacts.

THERMAL INFORMATION

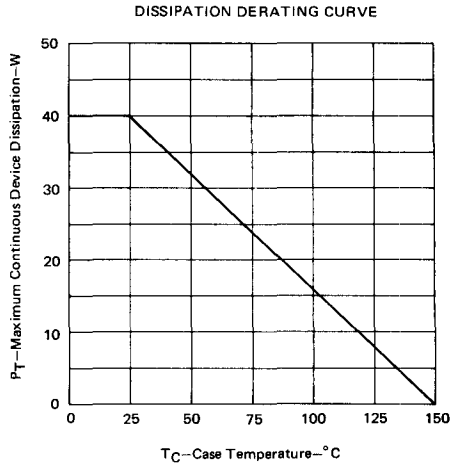

FIGURE 4

MAXIMUM SAFE OPERATING REGION

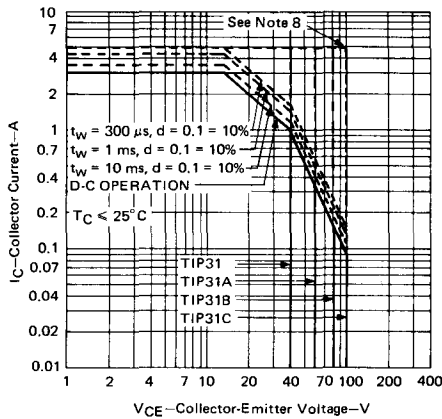

FIGURE 5

- NOTE 8: This combination of maximum voltage and current may be achieved only when switching from saturation to cutoff with a clamped inductive load.

**SILIZIUM-KOMPLEMENTARE-LEISTUNGSTRANSISTOREN
(Allgemeine und NF-Anwendungen)**

**SILICON COMPLEMENTARY POWER TRANSISTORS
(General and Low-frequency Applications)**

Type		$P_{tot}^{(a)}$	V_{CE0}	I_{CD}		h_{FE}	I_C
type		$T_C = 25\text{ }^\circ\text{C}$	min	max	min	max	A
NPN	PNP	(100 $^\circ\text{C}$)		A			
		W					A
BD 239	BD 240	30	45	2	40		0,2
BD 239 A	BD 240 A	30	60	2	40		0,2
BD 239 B	BD 240 B	30	80	2	40		0,2
BD 239 C	BD 240 C	30	100	2	40		0,2
BD 241	BD 242	40	45	3	25		1
BD 241 A	BD 242 A	40	60	3	25		1
BD 241 B	BD 242 B	40	80	3	25		1
BD 241 C	BD 242 C	40	100	3	25		1
BD 243	BD 244	65	45	6	30		0,3
BD 243 A	BD 244 A	65	60	6	30		0,3
BD 243 B	BD 244 B	65	80	6	30		0,3
BD 243 C	BD 244 C	65	100	6	30		0,3
BD 245	BD 246	80	45	10	40		1
BD 245 A	BD 246 A	80	60	10	40		1
BD 245 B	BD 246 B	80	80	10	40		1
BD 245 C	BD 246 C	80	100	10	40		1
BD 249	BD 250	125	45	25	25		1,5
BD 249 A	BD 250 A	125	60	25	25		1,5
BD 249 B	BD 250 B	125	80	25	25		1,5
BD 249 C	BD 250 C	125	100	25	25		1,5
TIP 29	TIP 30	30	40	1	40	200	0,2
TIP 29 A	TIP 30 A	30	60	1	40	200	0,2
TIP 29 B	TIP 30 B	30	80	1	40	200	0,2
TIP 29 C	TIP 30 C	30	100	1	40	200	0,2
TIP 31	TIP 32	40	40	3	25	100	1
TIP 31 A	TIP 32 A	40	60	3	25	100	1
TIP 31 B	TIP 32 B	40	80	3	25	100	1
TIP 31 C	TIP 32 C	40	100	3	25	100	1
TIP 33	TIP 34	80	40	10	40	125	1
TIP 33 A	TIP 34 A	80	60	10	40	125	1
TIP 33 B	TIP 34 B	80	80	10	40	125	1
TIP 33 C	TIP 34 C	80	100	10	40	125	1
TIP 35	TIP 36	90	40	25	25	100	1,5
TIP 35 A	TIP 36 A	90	60	25	25	100	1,5

f_T m n M Hz	I_{CES} @ (I_{CEO}) μA	VCE V	Gehäuse package	Anwendungen, Bemerkungen applications, remarks
			TO-66P TO-66P TO-66P TO-66P	
			TO-66P TO-66P TO-66P TO-66P	
			TO-66P TO-66P TO-66P TO-66P	Verstärker, Schalter amplifier, switch
			TO-3P TO-3P TO-3P TO-3P	
			TO-3P TO-3P TO-3P TO-3P	
3	200	40	TO-66P	Verstärker, Schalter, komplementär zu TIP 30 amplifier, switch, complementary to TIP 30
3	200	60	TO-66P	Verstärker, Schalter, komplementär zu TIP 30 A amplifier, switch, complementary to TIP 30 A
3	200	80	TO-66P	Verstärker, Schalter, komplementär zu TIP 30 B amplifier, switch, complementary to TIP 30 B
3	200	100	TO-66P	Verstärker, Schalter, komplementär zu TIP 30 C amplifier, switch, complementary to TIP 30 C
3	300	40	TO-66P	Verstärker, Schalter, komplementär zu TIP 32 amplifier, switch, complementary to TIP 32
3	300	60	TO-3P	Verstärker, Schalter, komplementär zu TIP 32 A amplifier, switch, complementary to TIP 32 A
3	300	80	TO-3P	Verstärker, Schalter, komplementär zu TIP 32 B amplifier, switch, complementary to TIP 32 B
3	300	100	TO-3P	Verstärker, Schalter, komplementär zu TIP 32 C amplifier, switch, complementary to TIP 32 C
3	400	40	TO-3P	Verstärker, Schalter, komplementär zu TIP 34 amplifier, switch, complementary to TIP 34
3	400	60	TO-3P	Verstärker, Schalter, komplementär zu TIP 34 A amplifier, switch, complementary to TIP 34 A
3	400	80	TO-3P	Verstärker, Schalter, komplementär zu TIP 34 B amplifier, switch, complementary to TIP 34 B
3	400	100	TO-3P	Verstärker, Schalter, komplementär zu TIP 34 C amplifier, switch, complementary to TIP 34 C
3	700	40	TO-3P	Verstärker, Schalter, komplementär zu TIP 36 amplifier, switch, complementary to TIP 36
3	700	60	TO-3P	Verstärker, Schalter, komplementär zu TIP 36 A amplifier, switch, complementary to TIP 36 A