

**MOTOROLA
SEMICONDUCTOR
TECHNICAL DATA**

2

**INTERNALLY COMPENSATED, HIGH PERFORMANCE
OPERATIONAL AMPLIFIERS**

... designed for use as a summing amplifier, integrator, or amplifier with operating characteristics as a function of the external feedback components.

- No Frequency Compensation Required
- Short-Circuit Protection
- Offset Voltage Null Capability
- Wide Common-Mode and Differential Voltage Ranges
- Low-Power Consumption
- No Latch Up

MAXIMUM RATINGS ($T_A = +25^\circ\text{C}$ unless otherwise noted)

Rating	Symbol	MC1741C	MC1741	Unit
Power Supply Voltage	V_{CC} V_{EE}	+18 -18	+22 -22	Vdc Vdc
Input Differential Voltage	V_{ID}	≈ 30		Volts
Input Common Mode Voltage (Note 1)	V_{ICM}	≈ 15		Volts
Output Short Circuit Duration (Note 2)	t_S	Continuous		
Operating Ambient Temperature Range	T_A	0 to +70	-55 to +125	$^\circ\text{C}$
Storage Temperature Range Metal and Ceramic Packages Plastic Packages	T_{stg}	-65 to +150 -55 to +125		$^\circ\text{C}$

NOTES:

1. For supply voltages less than -15 V, the absolute maximum input voltage is equal to the supply voltage
2. Supply voltage equal to or less than 15 V.

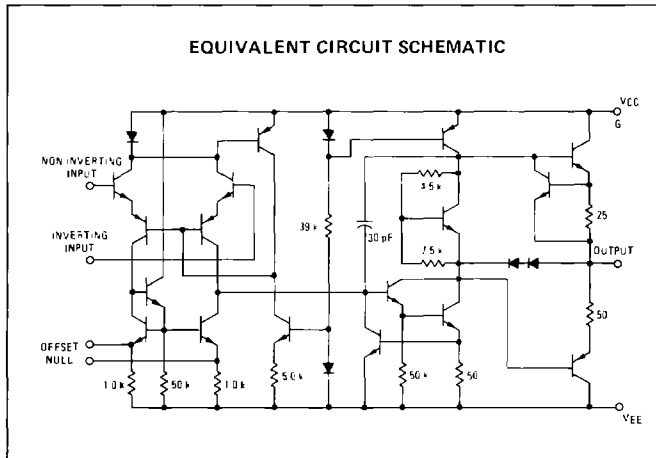

**MC1741
MC1741C**

OPERATIONAL AMPLIFIER

**SILICON MONOLITHIC
INTEGRATED CIRCUIT**

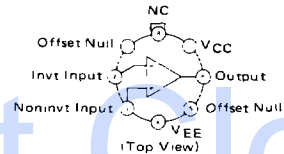

**G SUFFIX
METAL PACKAGE
CASE 601**

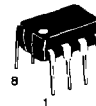

**P1 SUFFIX
PLASTIC PACKAGE
CASE 626**

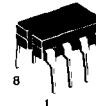

**U SUFFIX
CERAMIC PACKAGE
CASE 693**



**D SUFFIX
PLASTIC PACKAGE
CASE 751
(SO-8)**

PIN CONNECTIONS

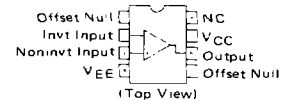

ORDERING INFORMATION

Device	Alternate	Temperature Range	Package
MC1741CD	—	0 $^\circ\text{C}$ to +70 $^\circ\text{C}$	SO-8
MC1741CG	LM741CH, $\mu\text{A}741\text{HC}$		Metal Can
MC1741CP1	LM741CN, $\mu\text{A}741\text{TC}$	-55 $^\circ\text{C}$ to +125 $^\circ\text{C}$	Plastic DIP
MC1741CU	—		Ceramic DIP
MC1741G	—	-55 $^\circ\text{C}$ to +125 $^\circ\text{C}$	Metal Can
MC1741U	—		Ceramic DIP

MC1741, MC1741C

ELECTRICAL CHARACTERISTICS ($V_{CC} = +15\text{ V}$, $V_{EE} = -15\text{ V}$, $T_A = 25^\circ\text{C}$ unless otherwise noted).

Characteristic	Symbol	MC1741			MC1741C			Unit
		Min	Typ	Max	Min	Typ	Max	
Input Offset Voltage ($R_S \leq 10\text{ k}\Omega$)	V_{IO}	—	1.0	5.0	—	2.0	6.0	mV
Input Offset Current	I_{IO}	—	20	200	—	20	200	nA
Input Bias Current	I_{IB}	—	80	500	—	80	500	nA
Input Resistance	r_i	0.3	2.0	—	0.3	2.0	—	$M\Omega$
Input Capacitance	C_i	—	1.4	—	—	1.4	—	pF
Offset Voltage Adjustment Range	$V_{IO\text{R}}$	—	± 15	—	—	± 15	—	mV
Common Mode Input Voltage Range	V_{ICR}	± 12	± 13	—	± 12	± 13	—	V
Large Signal Voltage Gain ($V_O = \pm 10\text{ V}$, $R_L \geq 2.0\text{ k}\Omega$)	A_v	50	200	—	20	200	—	V/mV
Output Resistance	r_o	—	75	—	—	75	—	Ω
Common Mode Rejection Ratio ($R_S \leq 10\text{ k}\Omega$)	CMRR	70	90	—	70	90	—	dB
Supply Voltage Rejection Ratio ($R_S \leq 10\text{ k}\Omega$)	PSRR	—	30	150	—	30	150	$\mu\text{V/V}$
Output Voltage Swing ($R_L \geq 10\text{ k}\Omega$) ($R_L \geq 2\text{ k}\Omega$)	V_O	± 12 ± 10	± 14 ± 13	—	± 12 ± 10	± 14 ± 13	—	V
Output Short-Circuit Current	I_{OS}	—	20	—	—	20	—	mA
Supply Current	I_D	—	1.7	2.8	—	1.7	2.8	mA
Power Consumption	P_C	—	50	85	—	50	85	mW
Transient Response (Unity Gain — Non-Inverting) ($V_i = 20\text{ mV}$, $R_L \geq 2\text{ k}\Omega$, $C_L \leq 100\text{ pF}$) Rise Time ($V_i = 20\text{ mV}$, $R_L \geq 2\text{ k}\Omega$, $C_L \leq 100\text{ pF}$) Overshoot ($V_i = 10\text{ V}$, $R_L \geq 2\text{ k}\Omega$, $C_L \leq 100\text{ pF}$) Slew Rate	T_{LH} os SR	—	0.3 15 0.5	— — —	—	0.3 15 0.5	—	μs % V/ μs

ELECTRICAL CHARACTERISTICS ($V_{CC} = +15\text{ V}$, $V_{EE} = -15\text{ V}$, $T_A = T_{low}$ to T_{high} unless otherwise noted).

Characteristic	Symbol	MC1741			MC1741C			Unit
		Min	Typ	Max	Min	Typ	Max	
Input Offset Voltage ($R_S \leq 10\text{ k}\Omega$)	V_{IO}	—	1.0	6.0	—	—	7.5	mV
Input Offset Current ($T_A = 125^\circ\text{C}$) ($T_A = -55^\circ\text{C}$) ($T_A = 0^\circ\text{C}$ to $+70^\circ\text{C}$)	I_{IO}	—	7.0 85 —	200 500 —	—	— — 300	—	nA
Input Bias Current ($T_A = 125^\circ\text{C}$) ($T_A = -55^\circ\text{C}$) ($T_A = 0^\circ\text{C}$ to $+70^\circ\text{C}$)	I_{IB}	—	30 300 —	500 1500 —	—	— — 800	—	nA
Common Mode Input Voltage Range	V_{ICR}	± 12	± 13	—	—	—	—	V
Common Mode Rejection Ratio ($R_S \leq 10\text{ k}\Omega$)	CMRR	70	90	—	—	—	—	dB
Supply Voltage Rejection Ratio ($R_S \leq 10\text{ k}\Omega$)	PSRR	—	30	150	—	—	—	$\mu\text{V/V}$
Output Voltage Swing ($R_L \geq 10\text{ k}\Omega$) ($R_L \geq 2\text{ k}\Omega$)	V_O	± 12 ± 10	± 14 ± 13	—	— ± 10	— ± 13	—	V
Large Signal Voltage Gain ($R_L \geq 2\text{ k}\Omega$, $V_{out} = \pm 10\text{ V}$)	A_v	25	—	—	15	—	—	V/mV
Supply Currents ($T_A = 125^\circ\text{C}$) ($T_A = -55^\circ\text{C}$)	I_D	—	1.5 2.0	2.5 3.3	—	— —	—	mA
Power Consumption ($T_A = +125^\circ\text{C}$) ($T_A = -55^\circ\text{C}$)	P_C	—	45 60	75 100	—	— —	—	mW

* $T_{high} = 125^\circ\text{C}$ for MC1741 and 70°C for MC1741C
 $T_{low} = -55^\circ\text{C}$ for MC1741 and 0°C for MC1741C



MC1741, MC1741C

2

FIGURE 1 – BURST NOISE versus SOURCE RESISTANCE

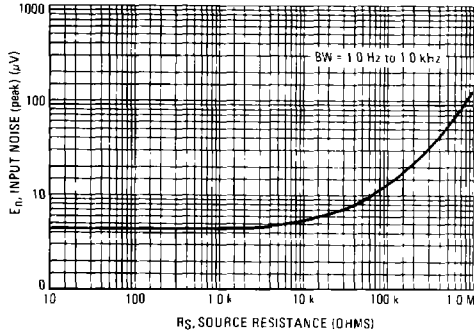

FIGURE 2 – RMS NOISE versus SOURCE RESISTANCE

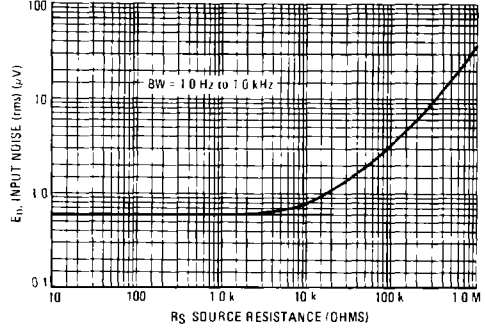

FIGURE 3 – OUTPUT NOISE versus SOURCE RESISTANCE

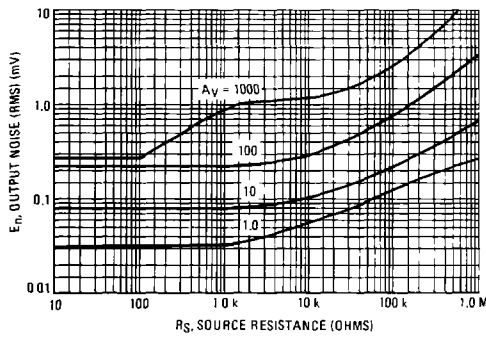

FIGURE 4 – SPECTRAL NOISE DENSITY

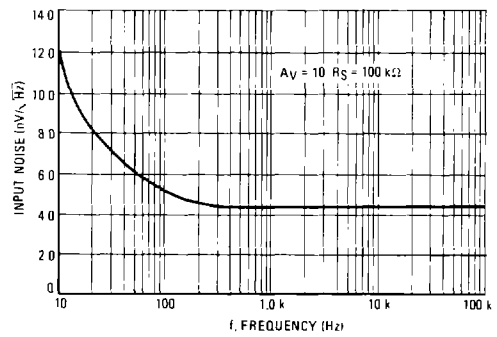
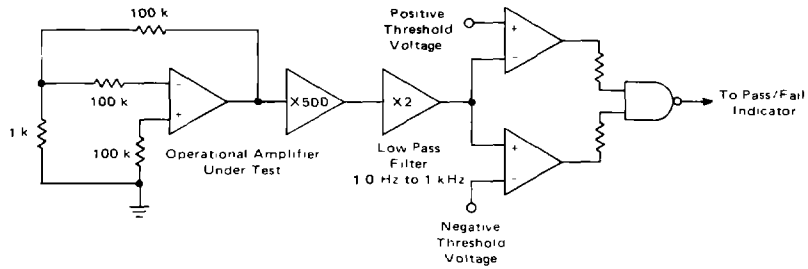

FIGURE 5 – BURST NOISE TEST CIRCUIT



Unlike conventional peak reading or RMS meters, this system was especially designed to provide the quick response time essential to burst (popcorn) noise testing

The test time employed is 10 seconds and the 20 μ V peak limit refers to the operational amplifier input thus eliminating errors in the closed-loop gain factor of the operational amplifier under test

MC1741, MC1741C

TYPICAL CHARACTERISTICS

($V_{CC} = +15$ Vdc, $V_{EE} = -15$ Vdc, $T_A = +25^\circ\text{C}$ unless otherwise noted)

**FIGURE 6 – POWER BANDWIDTH
(LARGE SIGNAL SWING versus FREQUENCY)**

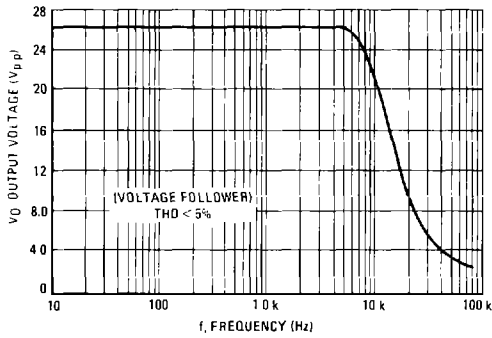
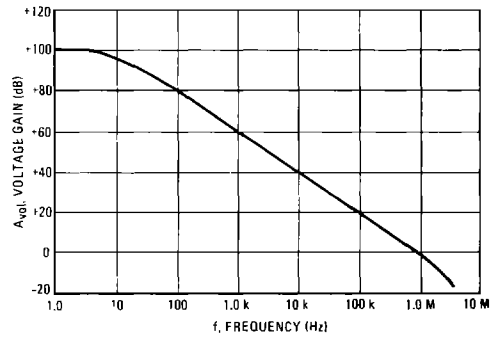
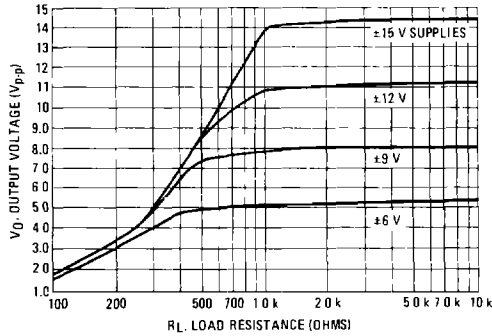

FIGURE 7 – OPEN LOOP FREQUENCY RESPONSE



**FIGURE 8 – POSITIVE OUTPUT VOLTAGE SWING
versus LOAD RESISTANCE**



**FIGURE 9 – NEGATIVE OUTPUT VOLTAGE SWING
versus LOAD RESISTANCE**

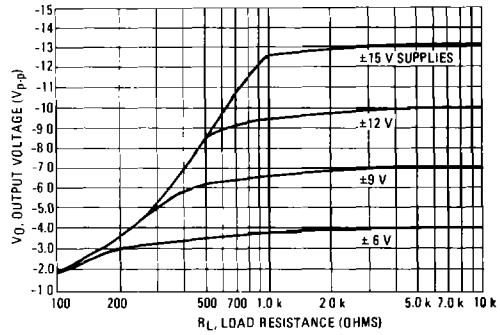

**FIGURE 10 – OUTPUT VOLTAGE SWING versus
LOAD RESISTANCE (Single Supply Operation)**

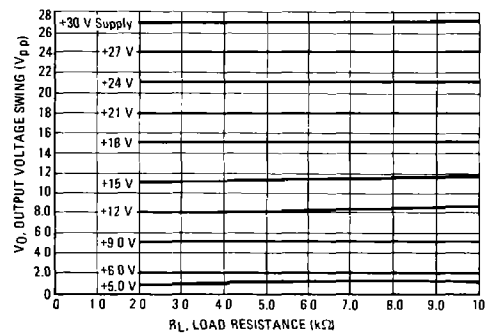

FIGURE 11 – SINGLE SUPPLY INVERTING AMPLIFIER

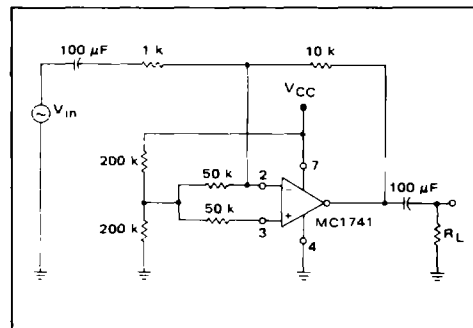

FIGURE 12 — NONINVERTING PULSE RESPONSE

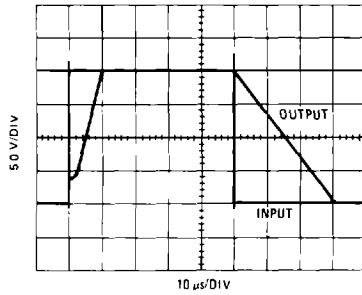

FIGURE 13 — TRANSIENT RESPONSE TEST CIRCUIT

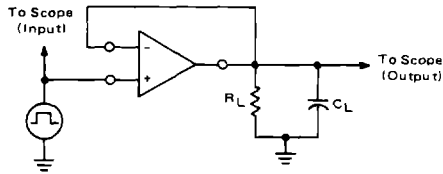

FIGURE 14 — OPEN LOOP VOLTAGE GAIN versus SUPPLY VOLTAGE

