

BD243, BD243A, BD243B, BD243C

1271

FOR POWER-AMPLIFIER AND HIGH-SPEED-SWITCHING APPLICATIONS
DESIGNED FOR COMPLEMENTARY USE WITH BD244A-C

- 65 W at 25 °C Case Temperature
- 6 A Rated Collector Current
- Min f_T of 3 MHz at 10 V, 500 mA

mechanical data

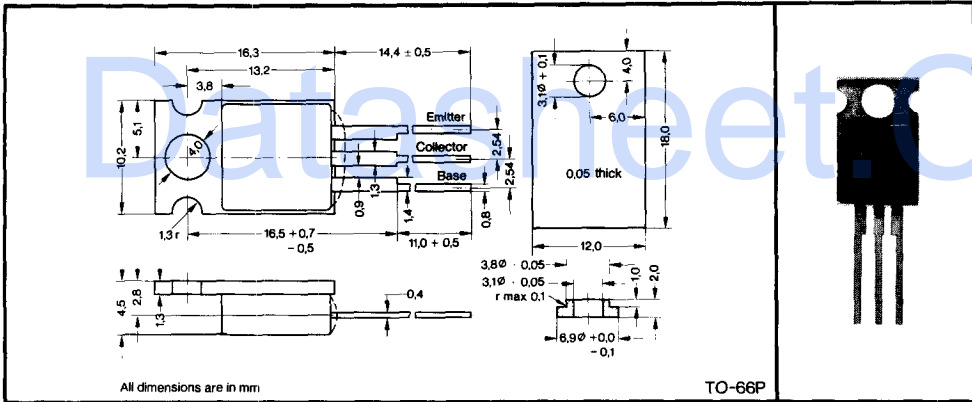

absolute maximum ratings at 25 °C case temperature (unless otherwise noted)

	BD243	BD243A	BD243B	BD243C
Collector-Emitter Voltage ($R_{BE} = 100 \Omega$)	55 V	70 V	90 V	115 V
Collector-Emitter Voltage (See Note 1)	45 V	60 V	80 V	100 V
Emitter-Base Voltage	†	†	5 V	→
Continuous Collector Current	†	†	6 A	→
Peak Collector Current (See Note 2)	†	†	10 A	→
Continuous Base Current	†	†	3 A	→
Safe Operating Region at (or below) 25 °C Case Temperature	†	†	See Figure 5	→
Continuous Device Dissipation at (or below) 25 °C Case Temperature (See Note 3)	†	†	65 W	→
Continuous Device Dissipation at (or below) 25 °C Free-Air Temperature (See Note 4)	†	†	2 W	→
Unclamped Inductive Load Energy (See Note 5)	†	†	62.5 mJ	→
Operating Collector Junction Temperature Range	†	†	-65 °C to 150 °C	→
Storage Temperature Range	†	†	-65 °C to 150 °C	→
Lead Temperature 1/8 Inch from Case for 5 Seconds	†	†	250 °C	→

- NOTES: 1. This value applies when the base-emitter diode is open-circuited.
 2. This value applies for $t_w \leq 0.3$ ms, duty cycle $\leq 10\%$.
 3. Derate linearly to 150 °C case temperature at the rate of 0.52 W/°C.
 4. Derate linearly to 150 °C free-air temperature at the rate of 0.52 W/°C.
 5. This rating is based on the capability of the transistor to operate safely in the circuit of Figure 2. $L = 20$ mH, $R_{BB1} = 100 \Omega$, $V_{BB2} = 0$ V, $R_S = 0.1 \Omega$, $V_{CC} = 10$ V. Energy $\approx I_C^2 L/2$.

PRELIMINARY DATA SHEET:
Supplementary data may be
published at a later date.

TEXAS INSTRUMENTS

2-39

BD243, BD243A, BD243B, BD243C

electrical characteristics at 25 °C case temperature

PARAMETER	TEST CONDITIONS	BD243		BD243A		BD243B		BD243C		UNIT
		MIN	MAX	MIN	MAX	MIN	MAX	MIN	MAX	
V _{(BR)CEO}	I _C = 30 mA, See Note 6	I _B = 0,	45		60		80		100	V
I _{CEO}	V _{CE} = 30 V, V _{CE} = 60 V,	I _B = 0 I _B = 0		0.7		0.7		0.7		mA
I _{CES}	V _{CE} = 45 V, V _{CE} = 60 V, V _{CE} = 80 V, V _{CE} = 100 V,	V _{BE} = 0 V _{BE} = 0 V _{BE} = 0 V _{BE} = 0		0.4		0.4		0.4		
I _{EBO}	V _{EB} = 5 V,	I _C = 0		1		1		1		mA
h _{FE}	V _{CE} = 4 V, See Notes 6 and 7	I _C = 0.3 A,	30		30		30		30	
	V _{CE} = 4 V, See Notes 6 and 7	I _C = 3 A,	15		15		15		15	
V _{BE}	V _{CE} = 4 V, See Notes 6 and 7	I _C = 6 A,		2		2		2		V
V _{CE(sat)}	I _B = 1.0 A, See Notes 6 and 7	I _C = 6 A,		1.5		1.5		1.5		V
h _{fe}	V _{CE} = 10 V, f = 1 kHz	I _C = 0.5 A,	20		20		20		20	
h _{fe}	V _{CE} = 10 V, f = 1 MHz	I _C = 0.5 A	3		3		3		3	

NOTES: 6. These parameters must be measured using pulse techniques. $t_w = 300 \mu s$, duty cycle $\leq 2\%$.

7. These parameters are measured with voltage-sensing contacts separate from the current-carrying contacts.

thermal characteristics

PARAMETER		MAX	UNIT
R _{θJC}	Junction-to-Case Thermal Resistance	1.92	°C/W
R _{θJA}	Junction-to-Free-Air Thermal Resistance	62.5	

switching characteristics at 25 °C case temperature

PARAMETER	TEST CONDITIONS ⁺			TYP	UNIT
t _{on}	I _C = 1 A,	I _{B(1)} = 0.1 A,	I _{B(2)} = -0.1 A,	0.3	μs
t _{off}	V _{BE(off)} = -3.7 V, R _L = 20 Ω,	See Figure 1		1	

⁺ Voltage and current values shown are nominal; exact values vary slightly with transistor parameters.

BD243, BD243A, BD243B, BD243C

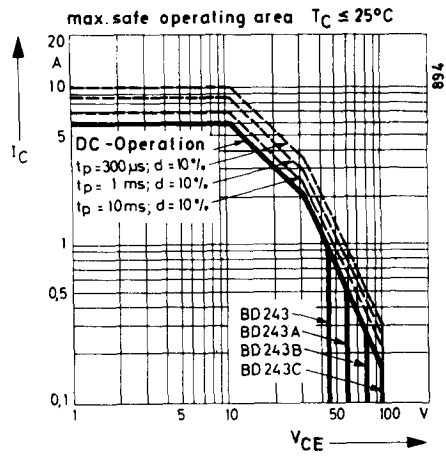
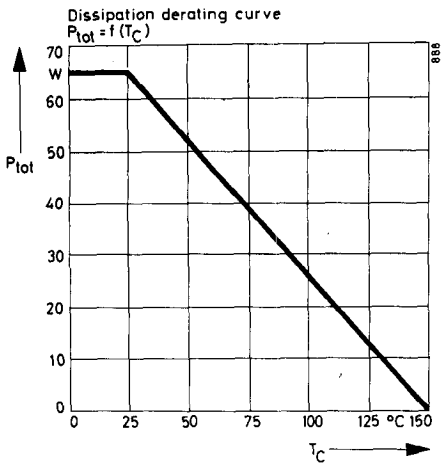
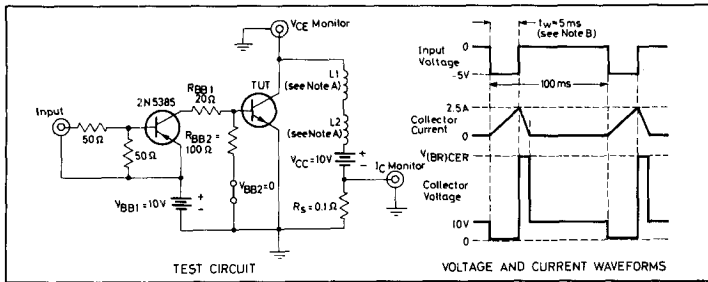
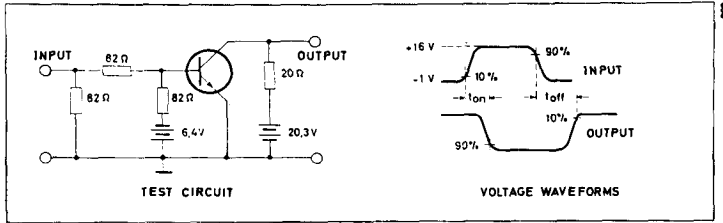

BD243, BD243A, BD243B, BD243C

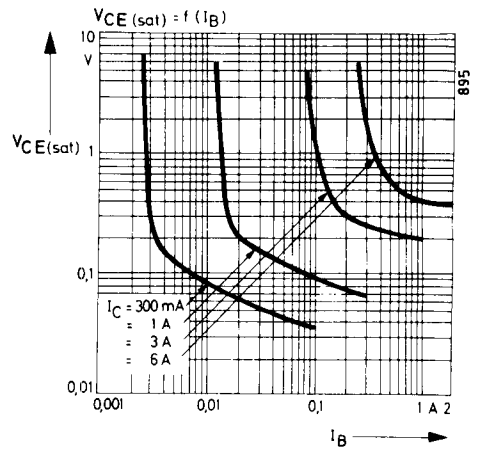
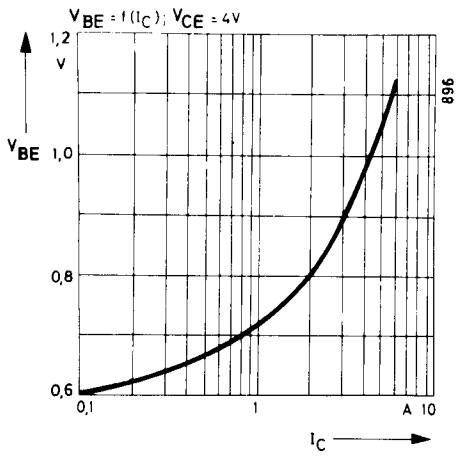

**SILIZIUM-KOMPLEMENTARE-LEISTUNGSTRANSISTOREN
(Allgemeine und NF-Anwendungen)**

**SILICON COMPLEMENTARY POWER TRANSISTORS
(General and Low-frequency Applications)**

Type		$P_{tot}^{(a)}$	V_{CE0}	I_{CD}		h_{FE}	I_C
type		$T_C = 25\text{ }^\circ\text{C}$	min	max	min	max	A
NPN	PNP	(100 $^\circ\text{C}$)		A			
		W					A
BD 239	BD 240	30	45	2	40		0,2
BD 239 A	BD 240 A	30	60	2	40		0,2
BD 239 B	BD 240 B	30	80	2	40		0,2
BD 239 C	BD 240 C	30	100	2	40		0,2
BD 241	BD 242	40	45	3	25		1
BD 241 A	BD 242 A	40	60	3	25		1
BD 241 B	BD 242 B	40	80	3	25		1
BD 241 C	BD 242 C	40	100	3	25		1
BD 243	BD 244	65	45	6	30		0,3
BD 243 A	BD 244 A	65	60	6	30		0,3
BD 243 B	BD 244 B	65	80	6	30		0,3
BD 243 C	BD 244 C	65	100	6	30		0,3
BD 245	BD 246	80	45	10	40		1
BD 245 A	BD 246 A	80	60	10	40		1
BD 245 B	BD 246 B	80	80	10	40		1
BD 245 C	BD 246 C	80	100	10	40		1
BD 249	BD 250	125	45	25	25		1,5
BD 249 A	BD 250 A	125	60	25	25		1,5
BD 249 B	BD 250 B	125	80	25	25		1,5
BD 249 C	BD 250 C	125	100	25	25		1,5
TIP 29	TIP 30	30	40	1	40	200	0,2
TIP 29 A	TIP 30 A	30	60	1	40	200	0,2
TIP 29 B	TIP 30 B	30	80	1	40	200	0,2
TIP 29 C	TIP 30 C	30	100	1	40	200	0,2
TIP 31	TIP 32	40	40	3	25	100	1
TIP 31 A	TIP 32 A	40	60	3	25	100	1
TIP 31 B	TIP 32 B	40	80	3	25	100	1
TIP 31 C	TIP 32 C	40	100	3	25	100	1
TIP 33	TIP 34	80	40	10	40	125	1
TIP 33 A	TIP 34 A	80	60	10	40	125	1
TIP 33 B	TIP 34 B	80	80	10	40	125	1
TIP 33 C	TIP 34 C	80	100	10	40	125	1
TIP 35	TIP 36	90	40	25	25	100	1,5
TIP 35 A	TIP 36 A	90	60	25	25	100	1,5

f_T m n M Hz	I_{CES} @ (I_{CEO}) μA	VCE V	Gehäuse package	Anwendungen, Bemerkungen applications, remarks
			TO-66P TO-66P TO-66P TO-66P	
			TO-66P TO-66P TO-66P TO-66P	
			TO-66P TO-66P TO-66P TO-66P	Verstärker, Schalter amplifier, switch
			TO-3P TO-3P TO-3P TO-3P	
			TO-3P TO-3P TO-3P TO-3P	
3	200	40	TO-66P	Verstärker, Schalter, komplementär zu TIP 30 amplifier, switch, complementary to TIP 30
3	200	60	TO-66P	Verstärker, Schalter, komplementär zu TIP 30 A amplifier, switch, complementary to TIP 30 A
3	200	80	TO-66P	Verstärker, Schalter, komplementär zu TIP 30 B amplifier, switch, complementary to TIP 30 B
3	200	100	TO-66P	Verstärker, Schalter, komplementär zu TIP 30 C amplifier, switch, complementary to TIP 30 C
3	300	40	TO-66P	Verstärker, Schalter, komplementär zu TIP 32 amplifier, switch, complementary to TIP 32
3	300	60	TO-3P	Verstärker, Schalter, komplementär zu TIP 32 A amplifier, switch, complementary to TIP 32 A
3	300	80	TO-3P	Verstärker, Schalter, komplementär zu TIP 32 B amplifier, switch, complementary to TIP 32 B
3	300	100	TO-3P	Verstärker, Schalter, komplementär zu TIP 32 C amplifier, switch, complementary to TIP 32 C
3	400	40	TO-3P	Verstärker, Schalter, komplementär zu TIP 34 amplifier, switch, complementary to TIP 34
3	400	60	TO-3P	Verstärker, Schalter, komplementär zu TIP 34 A amplifier, switch, complementary to TIP 34 A
3	400	80	TO-3P	Verstärker, Schalter, komplementär zu TIP 34 B amplifier, switch, complementary to TIP 34 B
3	400	100	TO-3P	Verstärker, Schalter, komplementär zu TIP 34 C amplifier, switch, complementary to TIP 34 C
3	700	40	TO-3P	Verstärker, Schalter, komplementär zu TIP 36 amplifier, switch, complementary to TIP 36
3	700	60	TO-3P	Verstärker, Schalter, komplementär zu TIP 36 A amplifier, switch, complementary to TIP 36 A

Typ type	f MHz	V _{CC}	P _{in}	P _{out}	BV _{CBO}	BV _{CEO}	Gehäuse package
2N 5713	150	13	3,4	11	60	40	TO-128
2N 5773	400	28	0,12	1,5	65	35	TO-117
2N 5774	400	26	1	8	65	35	TO-129
2N 5848	50	12,5	3,25	20	48	24	145

NF-TRANSISTOREN PNP/NPN NF TRANSISTORS PNP/NPN

Typ type		P _{tot} @ T _C = 25 °C (100 °C)	V _{CEO} min V	I _{CD} max A	min	hFE max	(@)	I _C A
PNP	NPN	W						
BD 136	BD 135	6,5	45	1	40	250		0,15
BD 138	BD 137	6,5	60	1	40	160		0,15
BD 140	BD 139	6,5	80	1	40	160		0,15
BD 240	BD 239	30	-45	-2	40			0,2
BD 240 A	BD 239 A	30	-60	-2	40			0,2
BD 240 B	BD 239 B	30	-80	-2	40			0,2
BD 240 C	BD 239 C	30	-100	-2	40			0,2
BD 242	BD 241	40	-45	-3	25			1
BD 242 A	BD 241 A	40	-60	-3	25			1
BD 242 B	BD 241 B	40	-80	-3	25			1
BD 242 C	BD 241 C	40	-100	-3	25			1
BD 244	BD 243	65	-45	-6	30			0,3
BD 244 A	BD 243 A	65	-60	-6	30			0,3
BD 244 B	BD 243 B	65	-80	-6	30			0,3
BD 244 C	BD 243 C	65	-100	-6	30			0,3
BD 246	BD 245	80	-45	-10	40			1
BD 246 A	BD 245 A	80	-60	-10	40			1
BD 246 B	BD 245 B	80	-80	-10	40			1
BD 246 C	BD 245 C	80	-100	-10	40			1
BD 250	BD 249	125	-45	-25	25			1,5
BD 250 A	BD 249 A	125	-60	-25	25			1,5
BD 250 B	BD 249 B	125	-80	-25	25			1,5
BD 250 C	BD 249 C	125	-100	-25	25			1,5
BDX 14		30	-60	-3	25	100		-0,5
BDX 15		117	-70	-10	20	70		-4

Typ type	f MHz	V _{CC}	P _{in}	P _{out}	BV _{CBO}	BV _{CEO}	Gehäuse package
2N 5941	30	28		40PEP	65	35	DIA-4L
2N 5942	30	28		80PEP	65	35	DIA-4L
2N 5943	250	15	50 mA	7 dB	40	30	TO-39

f _r MHz	I _{CS} (I _{CEO}) μA	@ V _{CE} V	Gehäuse package	Anwendungen, Bemerkungen applications, remarks
			SOT-32 SOT-32 SOT-32	P _{tot} = T _C 65 °C
			TO-66P TO-66P TO-66P TO-66P	
			TO-66P TO-66P TO-66P TO-66P	
			TO-66P TO-66P TO-66P TO-66P	Verstärker und Schalter amplifier and switch
			TO-3P TO-3P TO-3P TO-3P	
			TO-3P TO-3P TO-3P TO-3P	
0,8			TO-66	Schalter, Verstärker, komplementär 2N 3054
0,8			TO-3	Schalter, Verstärker, komplementär 2N 3055